



Kraus & Naimer

BLUE LINE switchgear

since 1907

Catalog 101 Optional Extras and Enclosures

08/2017

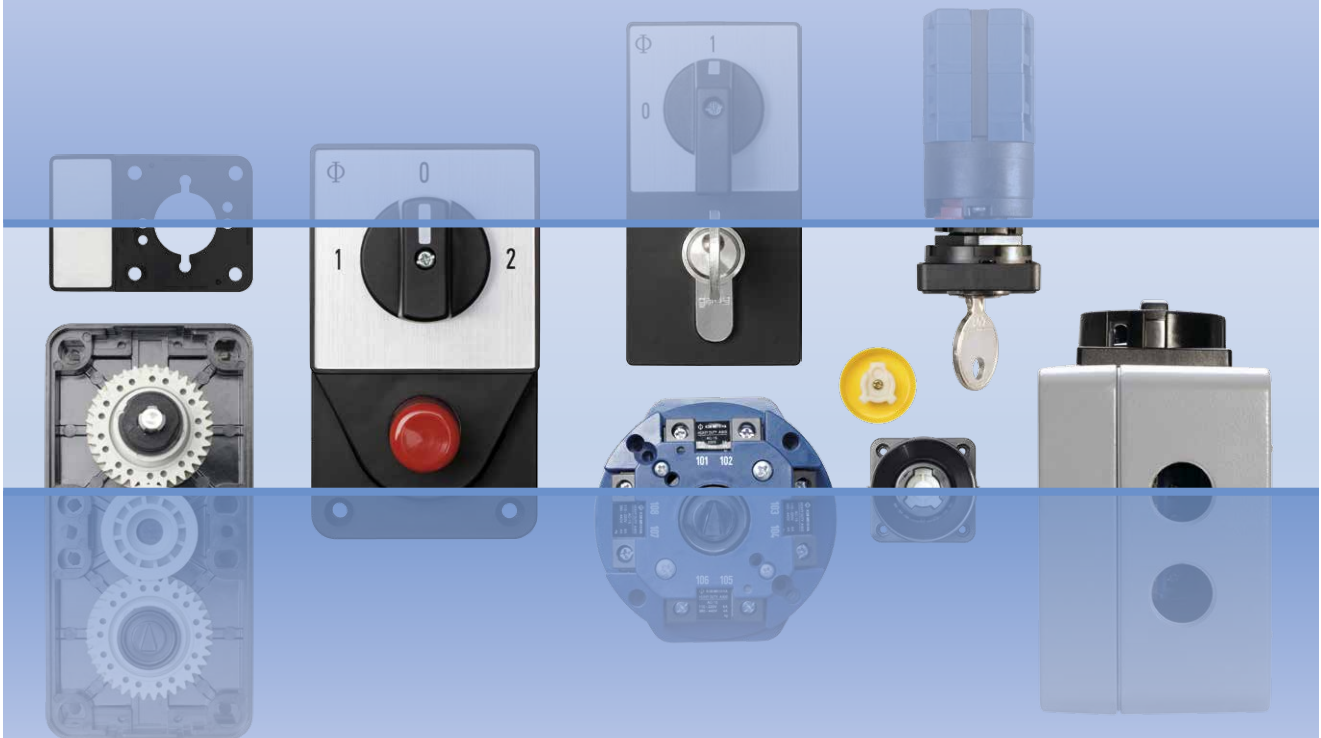

Kraus & Naimer

The development of the Blue Line rotary switch, contactor and motor starter product ranges is based on more than hundred years experience by Kraus & Naimer in the design and manufacture of electrical switchgear. Kraus & Naimer pioneered the introduction of the cam operated rotary switch and continues to be recognized as the world leader in that product field.

BLUE LINE

Blue Line products are protected by numerous patents throughout the industrial world. They are built to national and international standards and designed to withstand adverse temperatures and climates.

Blue Line products are accepted and universally recognized for their quality and workmanship. They are supported by a worldwide sales and service organization.

The Kraus & Naimer Registered Trademark



WORLDWIDE SYMBOL
FOR QUALITY SWITCHGEAR

Contents	Description Page	Dimensions Page
Construction Data	4	-
How to order	5	-
Optional Extras:		
Add-on Face Plates	24	41
Auxiliary Contacts	10	29
Bayonet/Switch Coupling	13	34
Door Clutches	7, 8	29, 30
Electromechanical Interlock	12	33
Ground and Neutral Terminal	13	35
Indicator Lamp Devices	8, 9	28, 31
Interlock between Switches	11	32
Key-lock Devices	17-20	36-39
Motor Drive	16	35
Padlock Devices	21	39, 40
Protective Cover	13	-
Push Button Interlock	12	33
Push-pull Interlock	11	32
Ratchet Coupling	15	34
Shaft Extension	6	28
Slip Clutch	15	34
Special Drive Units	14	35
Spring Return over several Positions	15	31
Stop and Go Device	11	31
Tandem Drives	13	32
Terminal Lugs	6	-
Trip Devices	16	34
Trip Indicator	10	-
Uni-directional Interlock	15	-
Switch Type Variations	23	40, 41
Enclosures	25-27	42-44
Blue Line Switchgear: Summary	46	-

Construction Data

The large cam switch line of the A, C, CA, CAD, CG, CH, CHR, D, L and X-series is complemented by a large number of optional extras and enclosures.

This substantial number of optional extras and enclosures is needed in order to meet the requirements of the world market.



One or more optional extras may be used in combination with any one switch provided they are of the same switch size. A few exceptions where this cannot be accomplished are noted on the following tables. In some cases, for technical strength or esthetic reason, it may be desirable that a switch be combined with an optional feature of the next larger switch size. Many options provide for such a possibility.

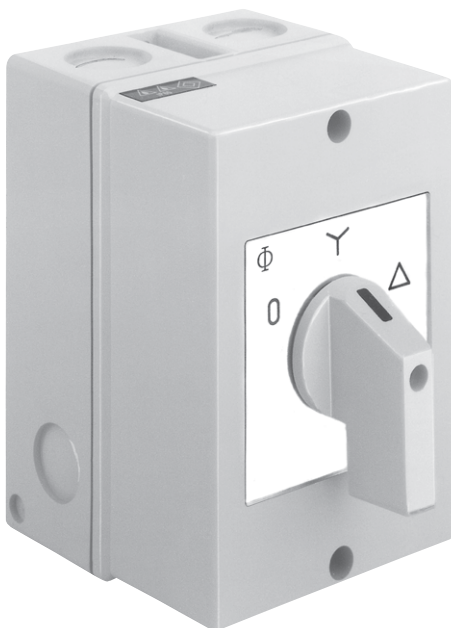

Enclosures are manufactured from plastic or aluminum material. They offer a high degree of protection (up to IP 66/67) thereby permitting switch operation under adverse environmental conditions. The materials used provide considerable strength and the best possible protection against corrosion. A large number of possibilities exist for combining switches, enclosures and appropriate optional extras.

How to order

Disconnectors and Main Switches with Optional Extras acc. to IEC 60947-3 see Catalog 500

When ordering Blue Line cam switches with optional extras, the following method of coding is required. Details on the enclosures and optional extras are shown in this catalog.

1. Switch Type

See Catalog 100, 110, 120, 130 or DC-Switch G20/G20S.

2. Switch Function

See Catalog 100, 110, 120, 130 or DC-Switch G20/G20S.

3. Type of Mounting

See Catalog 100, 110, 120, 130 or DC-Switch G20/G20S.

4. Enclosures

The assigned code numbers for the various enclosures are shown in this catalog on pages 25-27.

CA20B

**A202
V840G/**

PN

5. Optional Extras

Pages 6-24 list optional extras and their coding. A ● indicates the switch sizes in which the optional extra shown is available.

Possible combinations of switches of the same switch size with an optional extra of the next larger switch size are indicated by a ●. Only in this case indicate the next larger switch size in front of the coding.



There are some optional extras in existence which are available in a variety of programs. Additional ordering data may, therefore, be required. In the above case, a color description is required for the cover and handle disc.

< back to table of contents >

Switch Types	Size of Mounting	Switch Types	Size of Mounting	Switch Types	Size of Mounting	Switch Types	Size of Mounting
A11	S1	CA10R	S0	CH10B	S1	DHR12	S0
A11C	S2	CA10B	S1	CH16	S0	DH12B	S1
A25	S1	CA11	S0	CH16B	S1	DHR12B	S1
A25C	S2	CA11B	S1	CHR6	S00	G20	S0
C26	S1	CA20	S0	CHR10	S0	G20S	S0
C26C	S2	CA20B	S1	CHR10B	S1	L350	S2
C32	S1	CA25	S0	CHR16	S0	L351	S2
C32C	S2	CA25B	S1	CHR16B	S1	L400	S3
C42	S1	CA40	S1	DK10	S0	L600	S3
C43	S2	CA50	S1	DH10	S0	L630	S2
C80	S2	CA63	S1	DHR10	S0	L631	S2
C125	S2	CAD11	S0	DH10B	S1	L800	S3
C200-4	S2	CAD12	S0	DK11	S0	L1000	S2
C315	S3	CG4	S00	DH11	S0	L1200	S3
C316	S3	CG4-1	S00	DHR11	S0	L1600	S3
CA4	S00	CGD4-1	S00	DH11B	S1	L2000	S3
CA4N	S00	CG6	S00	DHR11B	S1	X200	S3
CA4-1	S00	CG8	S0	DK12	S0	X400	S3
CAD4-1	S00	CH6	S00	DKR12	S0	X630	S3
CA10	S0	CH10	S0	DH12	S0		

Optional Extras	Code	For Switch Sizes				
		S00	S0	S1	S2	S3

Terminal Lugs

	<p>For screw with wire clamps</p> <p>Terminal lugs facilitate the connecting of wires in installations where the terminals are not easily accessible.</p> <p>All X switches, L switches and switches type C315/ C316 will be supplied with terminal lugs as standard.</p>	M900		G20 G20S	A11 A25 C26 C32 C42	●	
			<p>Terminal lugs for quick connect termination</p> <p>Each quick connect terminal may accept either one 6,3 mm quick connect lug or two 2,8 mm quick connect lugs. Switch type CA4 only accepts one quick connect lug 2,8 mm.</p>	M930	1 CA4 CH6	1 CH10 CH16 DH10 DK10 G20 G20S	1 A11 A25 CH10B CH16B DH10B

Shaft extension

 <p><i>Dimensions p.28</i></p>	<p>With asymmetric profile</p> <p>Shaft length not adjustable</p> <p>Shaft with unlimited adjustable length with set screw with shear ring</p> <p>Adjustable shaft can be set to the desired length in a pre-mounted switch with VE mounting plate.</p>	L100 L100B M004D		●	●		
	 <p><i>Dimensions p.28</i></p>		<p>With square profile</p> <p>Shaft length not adjustable <input type="checkbox"/> 6 mm <input type="checkbox"/> 5 mm</p> <p>Shaft with unlimited adjustable length with set screw with clamping bushing</p>	L100A L105A M004E		●	●
<p>Ordering data:</p>		<p>Free shaft length or dimension from mounting surface to cover.</p>					

[< back to table of contents >](#)

¹The coding of the switch type may change as shown in Catalog 100, 120 and 130, page 6.

Optional Extras	Code	For Switch Sizes			
		S0	S1	S2	S3

Standard Door Clutch



Dimensions p. 30

With shaft extension, shaft with unlimited adjustable length
 shaft fixation with set screw
 Front protection IP 40
 Front protection IP 66/67

M280E
M280E/.EF

●	●	●	●	●
●	●	●	●	●



Dimensions p. 30

Door clutches M700/M701¹

Handle lockable with padlocks
 Protection IP 66
 The face Plate is available in black, yellow and alu.
 The handle may be supplied in black and red.

mm 4-8,5

M700/.

●	●	●	●	●
---	---	---	---	---



Dimensions p. 30

Standard handle and standard face plate Protection IP 65

The M700/M701 is a padlock door clutch and a mechanical interlocking safety device. Using the device the electrical panel may be opened only when the switch is in the OFF position and no padlock is fitted. Note: Only in the ON position can knowledgeable personnel using a simple tool to defeat the interlock. The M700's flexibility allows for successful installation with as much as + or - 5 mm of misalignment between the shaft and door.

M701/.

●	●	●		
---	---	---	--	--



Unlock insert for the M700 ff.
 To open the door in ON-position. (After the locking has been made inactive, it is necessary to take effective precautions against an opening of the door by unauthorized persons.)

S1D M700 29



Dimensions p. 30

Door clutches M800/M810.¹

Door clutch utilizes a simple and robust design and features a compact size. It has an interlock in the ON-position while a padlock can be fitted in the OFF-position. The door clutch may be opened only if the switch is in the OFF-position. In special cases, however, authorized people have a requirement to open the door, even if the switch is in the ON-position. Further characteristics are the single hole mounting with IP 66/67 protection degree, as well as the Accepted Misalignment up to ± 3 mm horizontally and ± 5 mm vertically. Maximum 3 padlocks with a minimum shackle diameter from 5 up to 8 mm are possible.

mm 5-8

M800/.

●	●			
---	---	--	--	--

M810/.

●				
---	--	--	--	--

Ordering data: Dimension from face of the switch to the cover or dimension from mounting surface to cover as well as the interlock program and the color selection.

¹Additional shaft extension must be specified.

Optional Extras	Code	For Switch Sizes			
		S0	S1	S2	S3

Simplified Door Clutch

 <p><i>Dimensions p. 29</i></p>	<p>Single hole mounting 22 mm, protection IP 66.</p> <p>Additional profile extension parts and shaft extension must be specified.</p> <p>For shaft extension For profile extension parts</p>	M295/A M295/B	●	●			
	<p>With padlock device and single hole mounting 22 mm, protection IP 66.</p> <p>Additional shaft extension must be specified.</p> <p>For 2 padlocks</p>			●	●		
	<p>For 2 padlocks</p>						
	<p>For 3 padlocks</p>						
	<p>For 4 padlocks</p>						
	<p>The cover disc is available in black, yellow and electro-gray. The handle may be supplied in red, black and electro-gray.</p>						
	<p>For 4 padlocks</p>						
	<p>Operation of the locking bar from the front. Available in black, red and electro-gray.</p>						
	<p>Centering aid for simplified door clutches with single hole mounting and shaft extension</p> <p>Misalignment between the shaft and mounting are compensated in all 4 directions.</p>	M600		●			
	<p><i>Dimensions p. 29</i></p>						
<p>Ordering data:</p>	<p>Free shaft length or dimension from mounting surface to cover or distance from face of the switch to the cover and color selection.</p>						



[< back to table of contents >](#)

Indicator Lamp Device (without Lamp)

 <p><i>Dimensions p. 31</i></p>	<p>With square face plate</p> <p>With white lamp socket¹ Without lamp socket</p> <p>The lamp socket for switch size S0 had been designed for glowing lamps with socket E10. For switches size S1, S2 and S3 the sockets are provided for lamps with thread E14.</p>	Q200/A1 Q200/A2	●	●	●	●
	<p>With rectangular face plate</p> <p>With white lamp socket¹ Without lamp socket</p>			●	●	
	<p>¹Additional colors on request.</p>					

Optional Extras	Code	For Switch Sizes			
		S00	S0	S1	S2

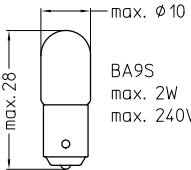
Control and Indicator Device (without Lamp)

	<p>For 1 lamp with socket BA 9s Max. power 2 W, Protection IP42</p> <p>The control and indicator device with total switching angle of 360° includes a single hole mounting 22/30 mm with locking nut and can be mounted and dismantled without tools.</p>	Q120¹	●		
<p>Dimensions p. 28</p>  <p>max. \varnothing 10 BA9S max. 2W max. 240V</p> <p>LED recommended</p>	<p>The following front end assemblies are available:</p> <ul style="list-style-type: none"> - Front ring (alternatively with add-on face plate) - Face plate 48 x 48 mm (alternatively with add-on face plate) - Face plate 64 x 64 <p>The operation may be as follows:</p> <ul style="list-style-type: none"> - Turn to operate - Push-to-turn operation (e.g. control and alarm switch) <p>The push-to-turn version is available with 1 or 2 auxiliary contacts and a mechanical interlock. Select between a contact system with rigid contact bridge for excellent AC-15 making and breaking capabilities. Also available with gold contacts for use in aggressive environments. Or select a H-bridge design with „cross-wire“ gold-plated contact system for low voltages and currents.</p>				
	<p>For 6 lamps with socket T6,8 Length of lamp 42-44 mm Max. power per lamp 2,5 W</p> <p>According to the operating voltage the lamps have to be paralleled or connected in series. As front end assembly an alu-face plate 51,8 x 51,8 mm is supplied.</p>	Q100/A	●		
<p>Dimensions p. 28</p>	<p>Ordering data: For size S0 front end assembly + function of the mechanical interlock, quantity and operation of the auxiliary contacts and type of the contact system.</p>				

¹ Ambient temperature: 35 °C during 24 hours with peaks up to 40 °C

Control and Indicator Device with Light Conductor

	<p>The luminous source is a LED module with yellow light-emitting diode mounted at the end of the switch. The transmission of light occurs via a light conductor.</p>	Q100B	●																												
<p>Dimensions p. 26</p>	<p>Technical Data:</p> <table border="1"> <thead> <tr> <th>Voltage</th> <th>Frequency</th> <th>Power Consumption</th> </tr> </thead> <tbody> <tr> <td>24 V</td> <td>AC 50 - 60 Hz, DC</td> <td>0,2 W</td> </tr> <tr> <td>48 - 60 V</td> <td>AC 50 - 60 Hz</td> <td>0,3 W</td> </tr> <tr> <td>48 - 60 V</td> <td>DC</td> <td>1 W</td> </tr> <tr> <td>110 - 120 V</td> <td>AC 50 - 60 Hz</td> <td>0,3 W</td> </tr> <tr> <td>110 - 120 V</td> <td>DC</td> <td>1,4 W</td> </tr> <tr> <td>220 - 240 V</td> <td>AC 50 - 60 Hz</td> <td>0,3 W</td> </tr> </tbody> </table> <p>with test terminal:</p> <table border="1"> <tbody> <tr> <td>24 V</td> <td>DC</td> <td>0,2 W</td> </tr> <tr> <td>48 - 60 V</td> <td>DC</td> <td>1 W</td> </tr> <tr> <td>110 - 120 V</td> <td>DC</td> <td>1,4 W</td> </tr> </tbody> </table> <p>Types of version Without interlock (handle "turn to operate") With interlock (handle "push to turn") The control and indicator device is available for single hole mounting and mosaic.</p>					Voltage	Frequency	Power Consumption	24 V	AC 50 - 60 Hz, DC	0,2 W	48 - 60 V	AC 50 - 60 Hz	0,3 W	48 - 60 V	DC	1 W	110 - 120 V	AC 50 - 60 Hz	0,3 W	110 - 120 V	DC	1,4 W	220 - 240 V	AC 50 - 60 Hz	0,3 W	24 V	DC	0,2 W	48 - 60 V	DC
Voltage	Frequency	Power Consumption																													
24 V	AC 50 - 60 Hz, DC	0,2 W																													
48 - 60 V	AC 50 - 60 Hz	0,3 W																													
48 - 60 V	DC	1 W																													
110 - 120 V	AC 50 - 60 Hz	0,3 W																													
110 - 120 V	DC	1,4 W																													
220 - 240 V	AC 50 - 60 Hz	0,3 W																													
24 V	DC	0,2 W																													
48 - 60 V	DC	1 W																													
110 - 120 V	DC	1,4 W																													
<p>Ordering data: Operating voltage and type of version.</p>																															

[< back to table of contents >](#)

Optional Extras	Code	For Switch Sizes			
		S0	S1	S2	S3

Trip Indicator

 <p>With square face plate</p> <p>With rectangular face plate</p> <p>The trip indicator used on switches with spring return positions. It includes a colored indicator to show the last spring return position that handle has been turned.</p> <p>Two possibilities for flag indicator exist:</p> <p>a) left red - right green</p> <p>b) left green - right red</p>	<p>M120/A</p> <p>M120/B</p>	●	●		
		●	●		
Ordering data:	The color to appear after left or right operation.				



Auxiliary Contacts

 <p>Dimensions p.29</p>	<p>These auxiliary contacts are controlled with a cam which can be programmed. The max. number of the auxiliary contacts for switches of size S1 and S2 is 4 pcs. and for switches of size S3 is 6 pcs.</p> <p>Select between a contact system with a rigid bridge for excellent AC-15 making and breaking capabilities or a H-bridge design with "cross-wire" contacts (sizes S1 and S2) for low voltages and currents. The contact systems with gold contacts or gold-plated contacts allow for use in aggressive environments also.</p> <p>In cases where more than 4 resp. 6 auxiliary contacts are required, an auxiliary switch should be used alternatively.</p>	<p>M510B</p>				
						<p>A11 C80</p> <p>A25 C125</p> <p>CA40 L350- ●</p> <p>CA50 L1000</p> <p>CA63</p> <p>C26</p> <p>C32</p> <p>C42</p>
Ordering data:	Quantity and operation of the auxiliary contacts and type of the contact system.					

[< back to table of contents >](#)

Optional Extras	Code	For Switch Sizes			
		S0	S1	S2	S3

Push-pull Interlock

 <p><i>Dimensions p. 32</i></p> <table border="1"> <tr> <td>AC-15</td> <td>220 V-240 V 380 V-440 V</td> <td>2,5A 1,5A</td> </tr> </table>  <p><i>Dimensions p. 32</i></p> <table border="1"> <tr> <td>AC-15</td> <td>240 V 500 V</td> <td>6A 3A</td> </tr> </table>	AC-15	220 V-240 V 380 V-440 V	2,5A 1,5A	AC-15	240 V 500 V	6A 3A	<p>To pull lateral spring return</p> <p>To pull lateral latching</p> <p>To push lateral spring return</p> <p>To push lateral latching</p> <p>The push-pull device is used to interlock the switch so that the handle can be rotated only when pushed or pulled. The push-pull device can be programmed to allow the interlock to operate only between pre-determined switch positions. Auxiliary contacts can be operated by means of the axial movement of the handle. For switches size S0 the max. number of auxiliary contacts is 2 pieces for all other sizes 8 pieces. In addition switches size S0 can also be combined with a trip indicator.</p>	<p>V110A</p> <p>V115A</p> <p>V130A</p> <p>V135A</p>	<p>●</p> <p>●</p> <p>●</p> <p>●</p>			
	AC-15	220 V-240 V 380 V-440 V	2,5A 1,5A									
AC-15	240 V 500 V	6A 3A										
<p>To pull lateral spring return</p> <p>To pull lateral latching</p> <p>To pull and to push lateral spring return</p> <p>To push lateral spring return</p> <p>To push lateral latching</p>	<p>V110</p> <p>V115</p> <p>V120</p> <p>V130</p> <p>V135</p>	<p>●</p> <p>●</p> <p>●</p> <p>●</p> <p>●</p>	<p>●</p> <p>●</p> <p>●</p> <p>●</p> <p>●</p>									
Ordering data:	Description of the interlocking program, number and operation of the auxiliary contacts.											

Stop and Go Device



 <p><i>Dimensions p. 31</i></p>	<p>The stop and go device prevents a fast switching thru the center OFF position. This is only possible with a 60° switching angle.</p> <p>The stop and go device only becomes activated in the center switch position, in either in both or one direction.</p>	<p>V160</p>	<p>●</p>			
Ordering data:	Operation of the stop and go device.					

Interlock between Switches

 <p><i>Dimensions p. 32</i></p>	<p>For 2 switch columns</p> <p>An interlock between 2 or 3 switch columns permits the operation of one switch only when the other switch or switches are located in a pre-determined switching position. For heavy duty service reinforced devices are available.</p>	<p>V600/B</p>	<p>●</p> <p>●</p> <p>●</p>			
	<p>For 3 switch columns</p>	<p>V600/C</p>	<p>●</p> <p>●</p> <p>●</p>			
Ordering data:	Description of the interlocking program.					

Optional Extras	Code	For Switch Sizes			
		S0	S1	S2	S3

Push Button Interlock

 <p>With square face plate</p> <p>Switching only possible if push button is pressed.</p> <p>Up to 4 auxiliary contacts can be operated by pressing the push button.</p>	<p>With rectangular face plate</p> <p>Switching only possible if push button is pressed.</p>	V400/A1	●	● ¹	●	●
 <p>Dimensions p. 33</p>	V400/B1		●	● ¹		
Ordering data:	Number and operation of the auxiliary contacts.					

Electromechanical Interlock²

 <p>For switches size S1</p> <p>The electromechanical interlock locks the switch in any switching position. The interlock device is operated by energizing or de-energizing the electromechanical system. Adding auxiliary contacts to the switch permits the device to be operated only in pre-determined positions.</p> <p>The optional extra S1 V140/2 can be equipped with a positive breaking auxiliary contact according to IEC 60947-5-1</p> <p>24 V - 600V 50Hz/60Hz 11 W Power Consumption</p>	<p>For switches size S2 and S3 or for switches size S1 with DC solenoid</p>	V140		●		
 <p>Dimensions p. 33</p>	<p>Magnet available Voltage: 24 V - 240V 50Hz/60Hz /DC 20 W Power Consumption</p>		V140		●	●
Ordering data:	Advise if the interlock is activated either by energizing or de-energizing of the electrical system. Coil voltage also required.					

[< back to table of contents >](#)

¹With auxiliary contacts available only up to switch type CA25B. ²Ambient temperature: 35 °C during 24 hours with peaks up to 40 °C.

Optional Extras	Code	For Switch Sizes				
		S00	S0	S1	S2	S3

Protective Cover

 <p>The protective cover prevents accidental contact with current-carrying terminals.</p>	M160					
				C26 C32 C42 A25	C80 C125	C315 C316 L400

Ground and Neutral Terminal

 <p><i>Dimensions p. 35</i></p>	Ground terminal	H040/E	●				
	Neutral terminal	H040/N	●				
	Ground and neutral terminal	H040/NE	●				

Tandem Drive





 <p><i>Dimensions p. 32</i></p>	For 2 switch columns	M300/B			●	●	●
	Two or three switch columns can be operated simultaneously. Special programs are available to reinforce the device for heavyduty applications.						
	For 3 switch columns	M300/C M300/D			●	●	●
	For 4 switch columns						●

Bayonet/Switch Coupling

 <p><i>Dimensions p. 34</i></p>	The device is used to couple switches into one column						
	Switches of the same size	M270			●	●	●
	Switches of different sizes	M275	●	●	●	●	●

Optional Extras	Code	For Switch Sizes			
		S0	S1	S2	S3

Special Drives

 <p><i>Dimensions p. 35</i></p>	<p>Heavy duty drive unit</p> <p>The device is designed to allow customer to couple his own operating device to the switch.</p>	<p>G800/A</p>	<p>●</p>		
 <p><i>Dimensions p. 35</i></p>	<p>Heavy duty drive unit with actuator and roller</p>	<p>G800/B</p>	<p>●</p>		
 <p><i>Dimensions p. 35</i></p>	<p>Double action lever</p>	<p>G800/C</p>	<p>●</p>		
 <p><i>Dimensions p. 35</i></p>	<p>Rope operation</p> <p>Available for spring return, maintained or stepping operation.</p>	<p>G900/B</p>	<p>●</p>		

[< back to table of contents >](#)

Optional Extras	Code	For Switch Sizes			
		S0	S1	S2	S3

Spring Return over several Positions

 <p>Dimensions p. 31</p>	<p>Spring return from both sides</p>	<p>M470/A</p> <p>M470</p>	● ●	● ●	● ●	● ●
	<p>Spring return from one side</p> <p>Spring return for angular displacement up to 30° can be accomplished by using the latching mechanism only. If a large number of contacts must be opened simultaneously or a total angular displacement is larger than 30° over which the spring return is operational, the switch must use one of the spring return devices.</p> <p>Spring return from both sides can be designed to permit maintained position on each side of center.</p>		● ●	● ●	● ●	● ●
<p>Ordering data:</p>	<p>For M470, specify spring return from either left or right side and details of maintained positions, if required.</p>					

Uni-directional Interlock

	<p>The uni-directional interlock prevents the switch from being operated counterclockwise. The interlock may be in either all positions or in pre-determined positions only.</p>	<p>M400</p>	● ●	● ●	● ●	● ●
	<p>Ordering data:</p>		<p>Specify which positions should be interlocked.</p>			

Slip Clutch and Ratchet Coupling

 <p>Dimensions p. 34</p>	<p>Slip clutch</p> <p>Using the slip clutch, two cam shafts can be coupled in such a way so that the secondary cam shaft will operate only after the primary cam shaft has been moved over a pre-determined angle. This slip clutch allows e. g. the de-energized changing back of switches for pole-changeable motors. Not available for D-switches.</p>	<p>M200</p> <p>M230</p>	● ●	● ●	● ●	● ●
	<p>Ratchet coupling</p> <p>A ratchet coupling attaches to the rear of the switch. Additional stages are then attached behind the coupling device which serves to operate that portion of the switch only when the handle is turned counterclockwise. When the handle is turned clockwise, the rear switch portion remains in the same position.</p>		<p>CA40</p> <p>CA50</p> <p>CA63</p> <p>C26</p> <p>C32</p>	● ●	● ●	● ●

[< back to table of contents >](#)

Optional Extras	Code	For Switch Sizes			
		S0	S1	S2	S3

Electromechanical Trip Device (Undervoltage Release)¹

 <p><i>Dimensions p. 34</i></p>	<p>Operating voltage and frequency:</p> <p>AC/50 Hz</p> <p>AC/60 Hz</p> <p>AC/50/60 Hz</p> <p>DC</p> <p>The device includes a magnetic system which releases the switch to the trip position at voltage failure or undervoltage of 70 % of the nominal voltage. The device is trip-free, in that the switch can be operated only when the primary voltage is available. When using DC voltage, an economy resistor must be provided.</p> <p>Switches with integrated undervoltage release are described on page 23.</p>	<p>V350/A</p> <p>V350/B</p> <p>V350/C</p> <p>V350/D</p>	<p>●</p> <p>●</p> <p>●</p> <p>●</p>			
	<p>Ordering data:</p> <p>Operating voltage and frequency for the magnetic system.</p>					

Electromechanical Trip Device (Shunt-trip)¹

 <p><i>Dimensions p. 34</i></p>	<p>The device permits the switch to be turned to the trip position by remote control. The coil is designed for short-time duty requiring an auxiliary contact in the switch which de-energizes the coil in the trip position.</p> <p>Controlling of the magnetic system: 24 V-440 V/50 Hz, 60 Hz or DC</p>	<p>V360/A</p>	<p>●</p>			
	<p>Ordering data:</p> <p>Operating voltage for the magnetic system.</p>					

































Motor Drive¹

 <p><i>Dimensions p. 35</i></p>	<p>The motor drive consists of an AC motor with capacitor, gear train and Geneva gear. This device allows switches to be operated from a remote location. Motor voltages available are 230 V, 50 Hz and 117 V, 60 Hz.</p> <p>Possible control systems:</p> <ul style="list-style-type: none"> - Follow-up control - Impulse control <p>Further information as well as special control systems upon request.</p>	<p>R300</p>	<p>●</p> <p>●</p> <p>●</p>			

¹Ambient temperature: 35 °C during 24 hours with peaks up to 40 °C.

Optional Extras	Code	For Switch Sizes			
		S00	S0	S1	S2















Key Lock device

	<p>For 1 stage switches in PN enclosure</p>	<p>V750/</p>	<p>CA11 CA20</p>		
<p><i>Dimensions p. 36</i></p>	<p>For 2 stage switches in PN enclosure</p>			<p>CA10- CA20</p>	
	<p>For 1 stage switches with plaster depth trim (With half-cylinder see page 19)</p>		<p>CA10</p>		
<p><i>Dimensions p. 36</i></p>					
	<p>For base mounting with type of mounting VE21</p>	<p>V750D/</p>	<p>CA4 CG4</p>	<p>●</p>	
<p><i>Dimensions p. 36</i></p>	<p>For single hole mounting combined with 16/22 mm, protection IP 66/67/69k</p>				
	<p>Micro-Kaba lock With front ring (mounting FS1) Face plate 30 x 30 mm (mounting FS2) Face plate 30 x 39 mm (mounting FS4)</p>	<p>V750D/1</p>		<p>●</p>	
<p><i>Dimensions p. 36</i></p>	<p>Locking program in which the key can be removed: A  B  E  F  G  R </p>				<p>●</p>
	<p>Lock 601 With front ring (mounting FS1) Face plate 30 x 30 mm (mounting FS2) Face plate 30 x 39 mm (mounting FS4)</p>	<p>V750D/2¹</p>		<p>●</p>	
<p><i>Dimensions p. 36</i></p>	<p>Locking program in which the key can be removed: C  G  M  H  P  D  N  J  Q </p>				<p>●</p>
	<p>For single hole mounting combined with 22 mm, protection 66/67/69k With front ring (mounting FT1) Face plate 48 x 48 mm (mounting FT2) Face plate 64 x 64 mm (mounting FH3) Face plate 48 x 59 mm (mounting FT6) Face plate 64 x 78,5 mm (mounting FH4)</p>	<p>V750D/3</p>		<p>●</p>	
<p><i>Dimensions p. 36</i></p>	<p>Locking program in which the key can be removed: C  G  M  H  P  K  D  N  J  Q  S </p>				<p>●</p>
<p>Ordering data:</p>	<p>Locking program of the key.</p>				

¹At high safety requirements use V750D/1.

Optional Extras	Code	For Switch Sizes			
		S0	S1	S2	S3

Key-lock Device with Kaba Lock

 <p>Dimensions p. 37</p>	<p>For single hole mounting 25 mm</p> <p>With front ring (mounting EL)</p>	<p>V750D/</p>	●			
 <p>Dimensions p. 37</p>	<p>For four hole panel mounting</p> <p>Face plate 48 x 48 mm (mounting E) Face plate 64 x 64 mm (mounting EG) Face plate 48 x 60 mm (mounting E) Face plate 64 x 78,8 mm (mounting EG)</p>		<p>V750D/A V750D/A V750D/B V750D/B</p>	●	●	●
 <p>Dimensions p. 37</p>	<p>For snap-on base mounting on track acc. to EN 50022</p> <p>With face plate for 45 mm knock-out (mounting VE2)</p> <p>Locking program in which the key can be removed:</p> <p>1A  1B  1C  1D  1E  1F  1G </p> <p>2G  2H  2J  2K  2L </p>	<p>V750D/</p>		●		
<p>Ordering data:</p>	<p>Locking program of the key.</p>					

[< back to table of contents >](#)

Key-lock Device with Profile Cylinder



 <p>Dimensions p. 37</p>	<p>The key-lock device V750E with profile cylinder is furnished with a single hole mounting 22 mm for switches in size S0. The key can be removed in one switch position or for switches with 60° switching angle in up to six switch positions. The device with profile cylinder can be supplied with standard lock cylinders manufactured by CES, BKS or IKON.</p>	<p>V750E</p>	●			
---	--	---------------------	---	--	--	--

Optional Extras	Code	For Switch Sizes			
		S0	S1	S2	S3

Key-lock Device with Kaba Lock

 <p><i>Dimensions p. 38</i></p>	<p>For single hole mounting 40 mm</p> <p>Face plate 64 x 64 mm (mounting EL2) With front ring (mounting EL1)</p> <p>Key can only be removed in the 12 o'clock position. Central locking systems are available.</p>	<p>V750/A1</p>	●	●		

Key-lock Device with Half-cylinder Lock

 <p><i>Dimensions p. 38</i></p>	<p>For switches with plaster depth trim</p> <p>For 1 stage switches in standard flush mounting box For multiple staged switches in special flush mounting box Protection IP 42</p> <p>The switch must have an arrested position in 12 o'clock. The key is only removable in the 12 o'clock position. The max. angular displacement is 2 x 135°.</p>	<p>V755.UE1</p>	BA20			
	<p>Dust cap for key-lock device Protection IP 43</p>	<p>S0D V755 12</p>				
 <p><i>Dimensions p. 38</i></p>	<p>For panel mounting Protection IP 42</p> <p>The key is removable in the 12 o'clock position. The max. angular displacement is 2 x 120°. Protection IP 42</p> <p>Additional programs with key removable in 2 positions are available on request.</p>	<p>V755.E</p>	●			

[< back to table of contents >](#)

Optional Extras	Code	For Switch Sizes			
		S0	S1	S2	S3

Safety-key-lock Device with separate Drive

 <p>With small cylinder lock</p> <p>Square face plate</p> <p>Rectangular face plate</p> <p><i>Dimensions p. 38</i></p>	V760/A.E	● ●	●		
	V760/B.E	● ●	●		
	V760/A	●	●	●	●
	V760/B	●	●		
 <p>With commercial half-cylinder lock</p> <p>Square face plate</p> <p>Rectangular face plate</p> <p><i>Dimensions p. 38</i></p>	V760/A	●	●	●	●
	V760/B	●	●		
 <p>With half-cylinder lock</p> <p>Square face plate</p> <p><i>Dimensions p. 38</i></p>	V765	●			
 <p>With dust cap</p> <p>Protection IP 43</p> <p><i>Dimensions p. 38</i></p>					

Various key positions and locking programs are available.

Key positions:

Key can be removed in locked and unlocked positions.

Key can be removed only in locked positions.

Locking programs:

Locking Program No.	Switching Angle	Switch Positions		Size
		To be locked	Not to be locked	
1	30°-90°	one	the balance	S0-S3
2	20°	all	none	S1, S3
	30°-90°			S0-S3
3	30°-90°	the balance	one	S1-S3
4 ¹	30°-90°	one ¹	the balance ¹	S0-S3

¹Locking program 4 permits the locking of the device in any switch position. However, the actual locking becomes effective in a pre-determined switch position only.

Ordering data: Advise locking program and positions in which the key can be removed.

Optional Extras	Code	For Switch Sizes				
		S00	S0	S1	S2	S3

Padlock Device



Dimensions p. 39

For 1 padlock
with lock bow diameter for 4-5,5 mm.
The handle may be supplied in black and red.



Dimensions p. 39

The padlock is an integral part of the switch handle itself and can hold 2 padlocks
The lock bar is accessible from the bottom. Handle can be sealed in the locked and unlocked positions. The handle may be supplied in black, red and electro-gray.



Dimensions p. 39

For mounting VE2 and VE21 with lock bar accessible from the front. Available in red and electro-gray.



Dimensions p. 39

For 4 padlocks
The lock bar is accessible from the front and may be supplied in black, red and electro-gray.







Spring loaded push rod

	S00	S0	S1	S2	S3
V840K mm 3,5-5,5	●				
V840A/A mm 4-6	●	●			
V840A/C mm 3-4,5	●				
V840B mm 4-6		●			
V845 mm 3-7 4-8 4-8,5 4-9	●	●	●	●	
V846 mm 4-8			●		

Ordering data: Color variation.

Optional Extras	Code	For Switch Sizes				
		S00	S0	S1	S2	S3

Padlock Device

 <p>Padlock device with integrated F- or B-handle</p> <p>The cover disc is available in black, yellow and electro-gray. The handle may be supplied in black, red and electro-gray.</p> <p>For 2 padlocks With F-handle</p> <p><i>Dimensions p. 39</i></p>	<p>mm</p> <p>V840D</p>	6-7				
		●				
 <p>For 3 padlocks</p> <p>With F-handle</p> <p>With B-handle</p> <p><i>Dimensions p. 39</i></p>	<p>mm</p> <p>V840G</p>	7-8,5				
	●	●				
	<p>mm</p> <p>V840D</p>	7-9,5				
	●		●			
 <p>For 4 padlocks</p> <p>With F-handle</p> <p>With B-handle</p> <p><i>Dimensions p. 39</i></p>	<p>mm</p> <p>V840F/F</p>	4-8				
	●	●				
	<p>mm</p> <p>V840F/B</p>	4-8				
	●	●				
 <p>For 2 padlocks For 3 padlocks For 6 padlocks</p> <p>Upon request, the device can be programmed to lock in several switch positions.</p> <p><i>Dimensions p. 40</i></p>	<p>mm</p> <p>V850</p>	3,5-7	3,5-7	4-7,5	4-7,5	
	●	●	●	●		
 <p>Padlock device for C switches with base mounting for locking when control cabinet is opened.</p> <p>Padlock device with simplified door clutch and single hole mounting see page 8.</p> <p><i>Dimensions p. 40</i></p>	<p>mm</p> <p>V841</p>	5-7,5				
	●	●	●			
 <p><i>Dimensions p. 40</i></p>	<p>mm</p> <p>V842</p>	5-7,5				
	●	●	●			
Ordering data:	Color variation.					

[< back to table of contents >](#)

Switch Type Variations

Suffix Code

For Switch Sizes

S0 | S1 | S2 | S3

PFR (Power Failure Release)¹



Dimensions p. 40

Size S0

The magnetic system includes a low hum DC coil with incapsulated diode rectifier (blocking voltage 1000 V) = it, therefore, works independent of frequency. PFR switches are available with 24 V-600 V coils.

Available switching detents: 1 x 60° (60° to the right of center OFF), 2 x 60° (60° to the right and left of center OFF).



Dimensions p. 40

Alternatively with trip-free release (Switching angle 1 x 60°)

The PFR switch series is designed to provide protection for both machines and machine operators by preventing the equipment (which has been operating) from restarting automatically after a power failure.

The device includes a magnetic system which releases the switch (by means of a linear spring return mechanism) to the trip position at voltage failure or undervoltage of 70 % of the nominal voltage.

Size S1

Operating voltage for the magnetic system:

24 V-500 V/50 Hz

24 V-600 V/60 Hz

(Switching angle 1 x 60°)

Ordering data:

Operating voltage for size S0 as well operating voltage and frequency for size S1 for the magnetic system.

X

CA..

Y

CA..
CG8

X

A25
CA40
CA50
CA63
C26
C32
C42

< back to table of contents >

Lockout-relay¹



Dimensions p. 41



Dimensions p. 41

With manual release

The lockout-relay is typically used to remotely switch electrical circuits from one power source to another.

The device contains a totally incapsulated coil and linear spring return mechanism which is compressed by manually turning the handle to the ON position (60° to the right of OFF). Once in the ON position, the handle is mechanically locked in place and cannot be manually turned back to OFF. When the coil is energized, however, the unit will automatically spring return to the OFF position.

A second version is available with push button manual release for test purposes.

Technical Data:

Voltage	Frequency	Power Consumption
24 - 28 V	AC 50 - 60 Hz, DC	135 VA
32 - 40 V	AC 50 - 60 Hz, DC	145 VA
42 - 50 V	AC 50 - 60 Hz, DC	155 VA
60 V	AC 50 - 60 Hz, DC	165 VA
110 - 125 V	AC 50 - 60 Hz, DC	185 VA
220 - 240 V*	AC 50 - 60 Hz, DC	220 VA
380 - 440 V*	AC 50 - 60 Hz, DC	240 VA

* for DC on request

Without manual release

Ordering data:

Operating voltage and frequency for the magnetic system.

M

CA10
CH..
A11
A25
CA40
CA50
CA63
C26
C42

L





CA10
CH..
A11
A25
CA40
CA50
CA63
C26

¹Ambient temperature: 35 °C during 24 hours with peaks up to 40 °C.

²In preparation.

Optional Extras	Code	For Switch Sizes				
		S00	S0	S1	S2	S3

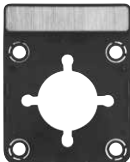
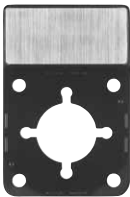
Rectangular Add-on Face plates

<p>Add-on face plates for switches with single hole mounting and four hole panel mounting</p> <p>The face plates can be engraved or embossed from the front or alternatively from the back. Face plates in different height are also available. The face plate frame is black, the face plate brushed aluminum. For switch sizes S0, S1, S2 and S3 yellow face plates are also available.</p> <p>Add-on face plates with black face plate frame, face plates brushed aluminum</p> <p>Switches with single hole mounting 22 mm and front ring</p>						
	For front inscription	F991/A0B/C-PRD F991/A0B-PRD	●	●		
	For inscription on the back		●	●		
	For front inscription	F991/A0B/C-PRB F991/A0B-PRB	●	●		
	For inscription on the back		●	●		
<p>Switches with single hole mounting or four hole panel mounting 22 mm and square face plate</p>						
	For front inscription	F991/A0B/C-PRC F991/A0B-PRC	●	●	●	
	For inscription on the back		●	●	●	
	For front inscription	F991/A0B/C-PRA F991/A0B-PRA	●	●	●	●
	For inscription on the back		●	●	●	●
<p>Face plates brushed aluminum</p>						
	For front inscription	F991/A00/C-P2B F991/A00-P2B	●	●	●	
	For inscription on the back		●	●	●	
	For front inscription	F991/A00/C-P2A F991/A00-P2A	●	●	●	●
	For inscription on the back		●	●	●	●
Ordering data:	Color variation, if differing from the described version.					

[< back to table of contents >](#)

Plastic Enclosures

Enclosure series protection IP 66/67, made of strong durable plastic, increased wiring space and cover coupling

KS and KL series

With high UV-resistance, Flammability Standard: UL94 V-0

CS and CL series

For applications in an aggressive environment, such as oil, chemical substances and grease

Each enclosure has 2 knock-outs on top and bottom for metric thread according to EN 50262. Standard equipment includes both a ground and neutral terminal. Size S0 enclosures are also available with lateral conduit knock-out and a cover interlock which allows for opening without dismantling the handle. They can also be supplied with a cover locked in 1 position. These enclosures are also available for conduit entries for PG-thread.



The following switch types can be mounted:

Switch type	Max. no. of stages
CA4	3
CG4	2
CG6	2

KS3/CS3

M16

Without cover interlock

**KS10/CS10
KS50/CS50**

M25
M20

With cover interlock (the enclosure can only be opened at 9 o'clock position)

**KS11/CS11
KS51/CS51**

M25
M20



With cover interlock (the enclosure can only be opened at 12 o'clock position)

**KS12/CS12
KS52/CS52**

M25
M20

The following switch types can be mounted:

Switch type	Max. no. of stages
CA10	6
CA11, CA20	5
CA25, CG8, CH10-CHR16	4

Without cover interlock

**KL10/CL10
KL50/CL50**

M25
M20

With cover interlock (the enclosure can only be opened at 9 o'clock position)

**KL11/CL11
KL51/CL51**

M25
M20



With cover interlock (the enclosure can only be opened at 12 o'clock position)

**KL12/CL12
KL52/CL52**

M25
M20

The following switch types can be mounted:

Switch type	Max. no. of stages
CA10	3
CA11	2
CA20, CA25, CG8	2
CH10-CHR16	2

Dimensions p. 42

Plastic Enclosures (Front Drive)



Protection IP 65

Conduit entries with metric ISO-thread

The following switch types can be mounted:

Switch type	Max. no. of stages
A11, A25	7
CA10, CA11, CA20, CA25, CA10B ¹ , CA11B, CA20B, CH10, CH16	4
CA40, CA50, CA63	6
C26, C42	4
C32	5

PF1

M20

M20

PF4

M25



Protection IP 42

Conduit entries with metric ISO-thread

The following switch types can be mounted:

Switch type	Max. no. of stages
A11, A25	6
CA10, CA11, CA20, CA25, CA10B ¹ , CA11B, CA20B, CH10, CH16	4
CA40, CA50, CA63	6
C26, C32	4
C42	3

PN1

M20

M20

PN4

M25



[Dimensions p. 43](#)



A lamp can be installed on request.

¹Only for 4 stages.

Enclosures	Code	For Switch Sizes			
		S0	S1	S2	S3

Plastic Enclosures



[Dimensions p. 44](#)

- Protection IP 44
- Conduit entries with metric ISO-thread
- Conduit entries without thread

The following switch types can be mounted:

Switch type	Max. no. of stages
A11	12
CA10, CA10R	12
CA11, CA20, CAD11, CAD12	12
CA10B, CA11B, CA20B	12

PK1

M25

M25

PK9



< back to table of contents >

Aluminum Enclosures



[Dimensions p. 44](#)

- Protection IP 65
- Conduit entries with metric ISO-thread
- Without conduit entries

The following switch types can be mounted:

Switch type	Max. no. of stages
A11, A25	10
CA10, CA10R	3
CA11	2
CA20	2
CA10B	12
CA11B	10
CA20B	10
CA25B	9
CA40, CA50, CA63	10

Additional conduit entries on request.

GK1

M20

M20

GK9



Shaft Extension

L100, L100A, L105A

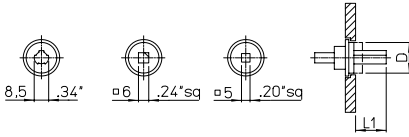

Free shaft length for

	E/EF	KN1/KD1	KD2	VE
S0	L1-2,3	L1-5,1	-	L1
S1	L1-2,5	-	L1-2,5	L1

Size	L1	L1	L1	L1	L1	L1	L1	L1	L1
S0	19	24	28	32	37	42	47	52	57
S1	19,8	23,8	27,8	32,8	37,8	42,8	47,8	52,8	57,8

Size	D
S0	13,8 .54
S1	18,5 .73

	L1	L1	L1	L1	L1	L1	L1	L1	L1
S0	62	67	72	77	82	87	92	97	102
S1	62,8	67,8	72,8	77,8	82,8	87,8	92,8	97,8	102,8

M004D, M004E

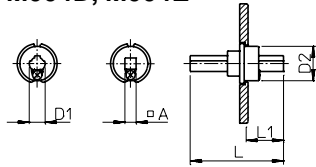

L = Shaft length
L1 = Free shaft length max.
1 = Only for square shaft

Size	L ¹	L1 ¹	L	L1	L	L1	L	L1	L	L1	D1	D2	A	SW
S0			60 2.36	40 1.57	80 3.15	60 2.36	100 3.94	80 3.15	120 4.72	100 3.94	6 .24	13,8 .54		12 .47
S1	56,5 2.22	20 .79	70 2.76	40 1.57	90 3.54	60 2.36	110 4.33	80 3.15	130 5.12	100 3.94	8,5 .34	18,5 .73	6 .24	16 .63
S2	70 2.76	40 1.57	100 3.94	70 2.76	130 5.12	100 3.94	160 6.30	130 5.12	190 7.48	160 6.30	11,2 .44	24,6 .97	8 .32	22 .87
S3	95 3.74	40 1.57	130 5.12	75 2.95	165 6.50	110 4.33	200 7.87	145 5.71	235 9.25	180 7.09	14 .55	35,1 1.38	10 .39	39 1.18

Control and Indicator Device (without Lamps)

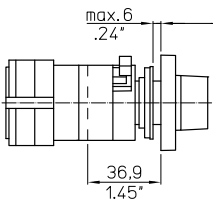

S0 Q120/A1 - S0 Q120/A5

Q120 Turn to operate
C-, DH-switches

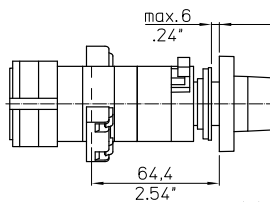

S0 Q120/A..A1 - S0 Q120/M..D5

Q120 Push-to-turn operation with a/c
C-, DH-switches

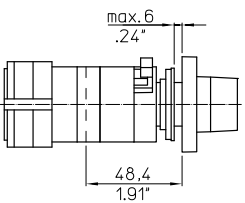

S0 Q120/A00Z1 - S0 Q120/Z00Z5

Q120 Push-to-turn operation without a/c
C-, DH-, DK-switches

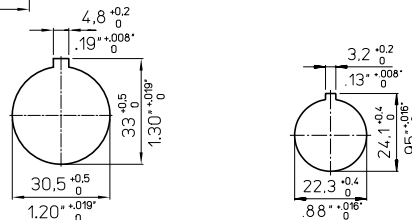

With adaptor ring

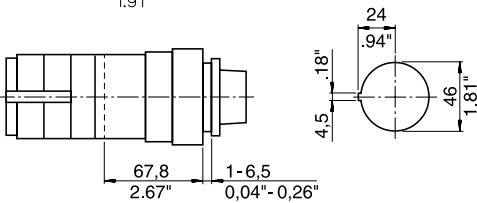

Q100/A

Face plate

51,8 x 51,8 mm

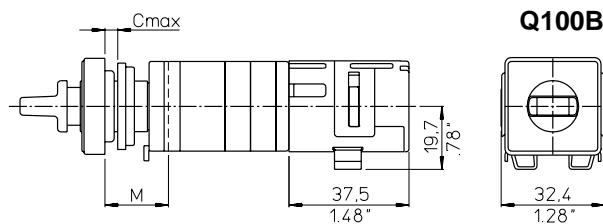

Q100B

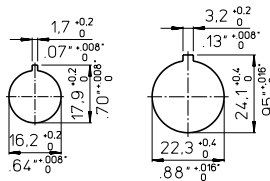

Without interlock

M = 17,7 C = 5

.70 .20

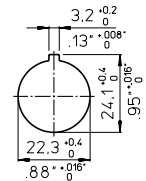

With interlock

M = 19,5 C = 6,5

.77 .26

Auxiliary Contacts

M510B

E mounting

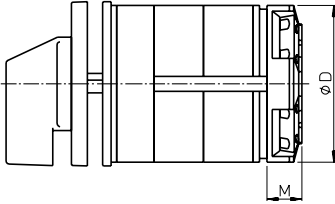

Size	M	D
S1	16.63	64.252
S2	18.74	84.331
S3	17.67	128.504

VE mounting

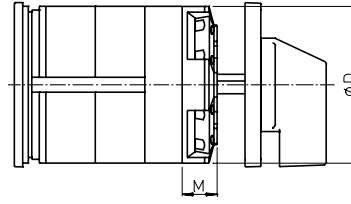

Size	M	D
S1	11.545	64.252
S2	11.746	84.331
S3	8.31	128.504

Simplified Door Clutch

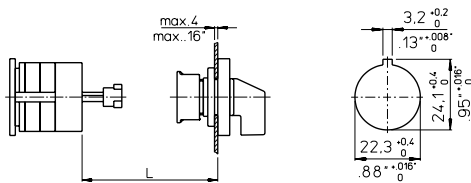

		L	
		min.	max.
M295/A	S0/S1	27.106	112.441
M295/B	S0/S1	25.98	90.354

V840E

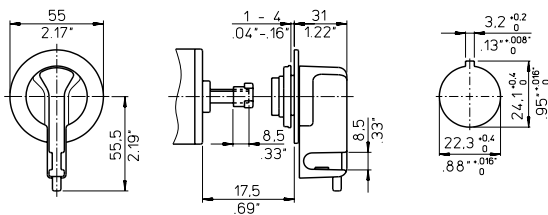

V840F/V840G

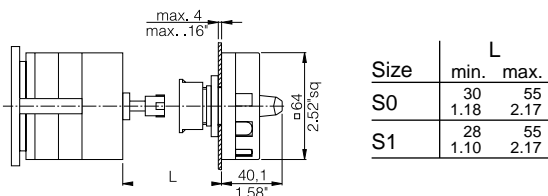

Size	L	
	min.	max.
S0	30.118	55.217
S1	28.110	55.217

V845

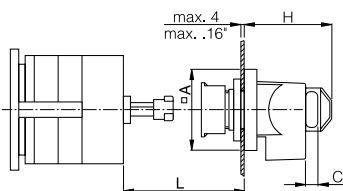

Size	A	C	H	L	
	min.	max.	min.	max.	
S0	48.189	7.28	52.205	30.118	55.217
S1	64.252	8.132	58.228	28.110	55.217

M600

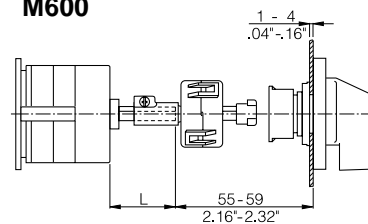

L see L100 and M004D page 28.

Standard Door Clutch

M280D, M280D/.EF, M280E, M280E/.EF

For switches of size S0

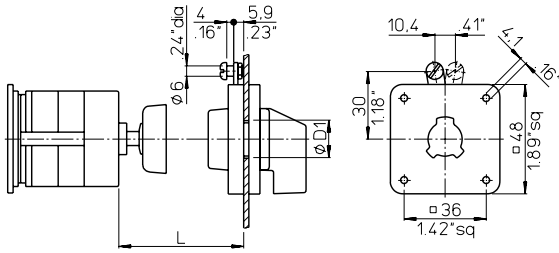

For switches of size S1 and S0 ●

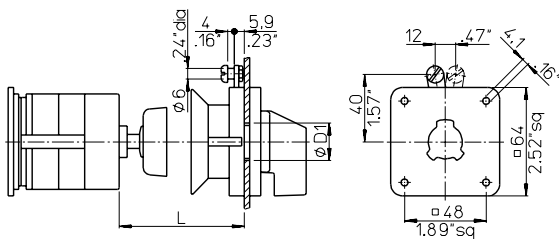

For switches of size S2 and S3

L = Shaft length

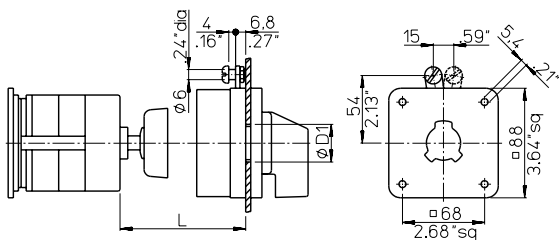

Size	L	L	L	L	D1
S0	36	55	56	75	19-22
	1.42	2.17	2.20	2.95	.75-.87
S0 ●	36	55	56	75	19-22
	1.42	2.17	2.20	2.95	.75-.87
S1	32	57	58	77	19-22
	1.26	2.24	2.28	3.03	.75-.87
S2	60	90	90	120	26-30
	2.36	3.54	3.54	4.72	1.02-1.18
S3	60	95	95	130	26-30
	2.36	3.74	3.74	5.12	1.02-1.18

M700

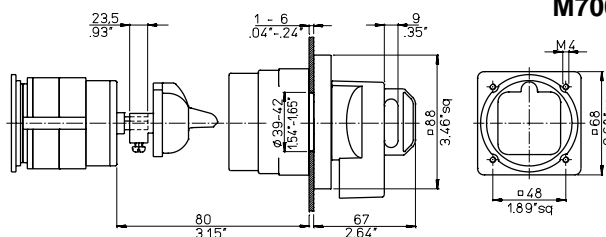

M701

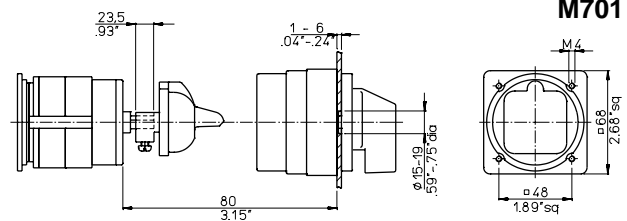

M800

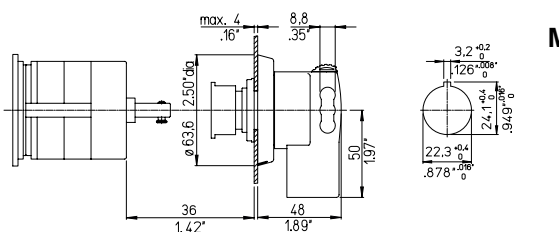

M810

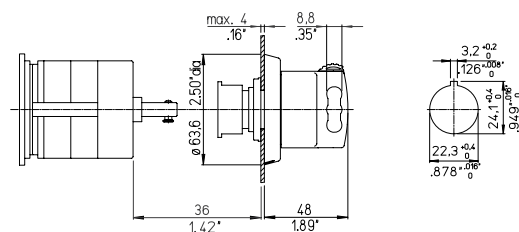

Indicator Lamp Device

Q200/A1, Q200/A2, Q200/B1, Q200/B2

For switches of size S0

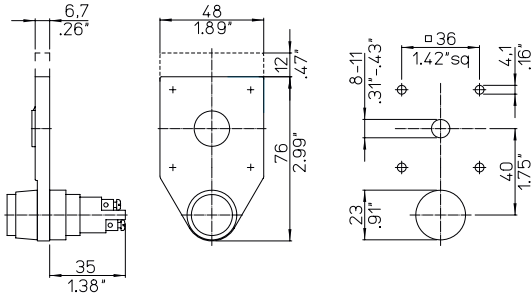

For switches of size S1

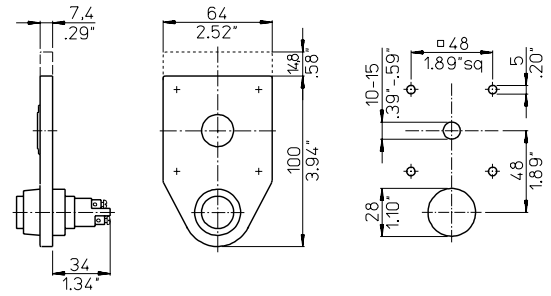

For switches of size S2

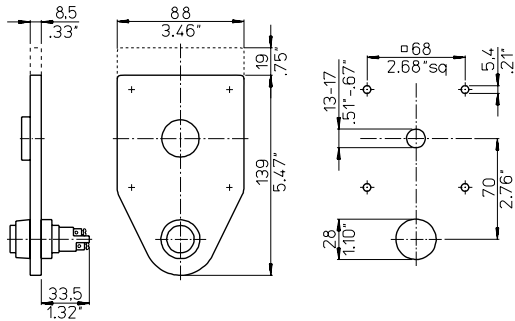

For switches of size S3

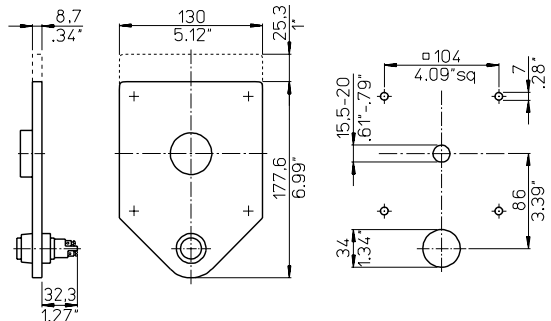

< back to table of contents >

Stop and Go Device

V160

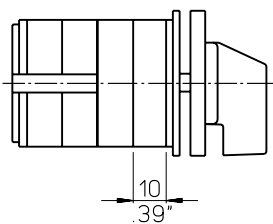

Spring Return over several Positions

M470/A, M470

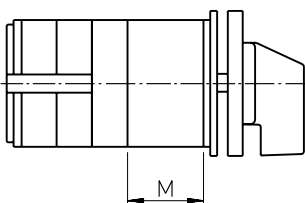

Size	M470/A M	M470 M
S0 ●	33,3 1.31	33,3 1.31
S0 ¹ ●	40,3 1.59	29,2 1.15
S1 ¹	33,3 1.31	22,2 .87
S2	75 2.95	

¹ shaft hole 18,5 mm/.73 inch

Push-pull Interlock

V110A, V115A, V130A, V135A

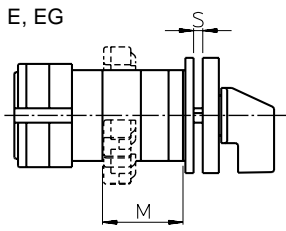

M = Additional length of the switch

Mounting	E ¹		EG ²		FT2		FH3	
	V110A V130A	V115A V135A	V110A V130A	V115A V135A	V110A V130A	V115A V135A	V110A V130A	V115A V135A
M w/o a/c	17,5 .69	33,5 1.32	24,5 .96	40,5 1.59	24,0 .94	40,0 1.57	31,0 1.22	47,0 1.85
M with a/c	33,5 1.32	33,5 1.32	40,5 1.59	40,5 1.59	40,0 1.57	40,0 1.57	47,0 1.85	47,0 1.85
S	1-4 .04-.16	1-4 .04-.16	1-2 .04-.08	1-2 .04-.08	1-6 .04-.24	1-6 .04-.24	1-6 .04-.24	1-6 .04-.24

¹shaft hole 15-19 mm/.59-.75 inch
²shaft hole 19-22 mm/.75-.87 inch

FT2, FH3

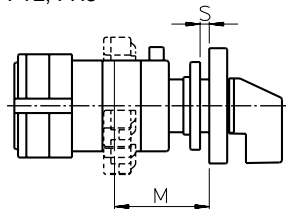

V110, V115, V130, V135

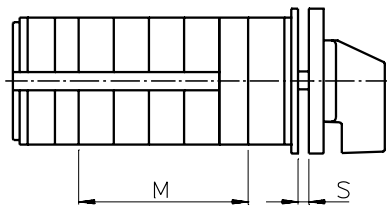

M = Additional length of the switch

Size	No. of auxiliary contacts				S
	0-2	3 + 4	5 + 6	7 + 8	
S1 ¹	39,9 1.57	57,4 2.26	74,9 2.95	92,4 3.64	0-4 0-.16
S1	29,5 1.16	47 1.85	64,5 2.54	82 3.23	0-4 0-.16

¹For switch type CA..B, CH..B, CG..B, DH..B

V110, V120, V130

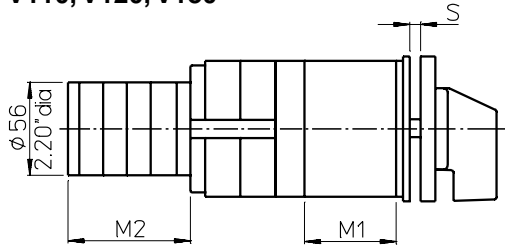

M1 = Additional length of the switch

M2 = Additional length of the auxiliary switch

Size	No. of auxiliary contacts					S
	0	1 + 2	3 + 4	5 + 6	7 + 8	
S1 ¹	51,7 2.04	101,4 3.99	120,4 4.74	139,4 5.49	158,4 6.24	0-4,5 0-.18
S2	69 2.72	127,6 5.02	146,6 5.77	165,6 6.52	184,6 7.27	0-5,5 0-.22
S3	85 3.35	151,6 5.96	170,5 6.71	189,5 7.46	208,5 8.21	0-7 0-.28

¹Only for V120

Interlock between Switches and Tandem Drive

V600/B, V600/C, M300/B, M300/C, M300/D

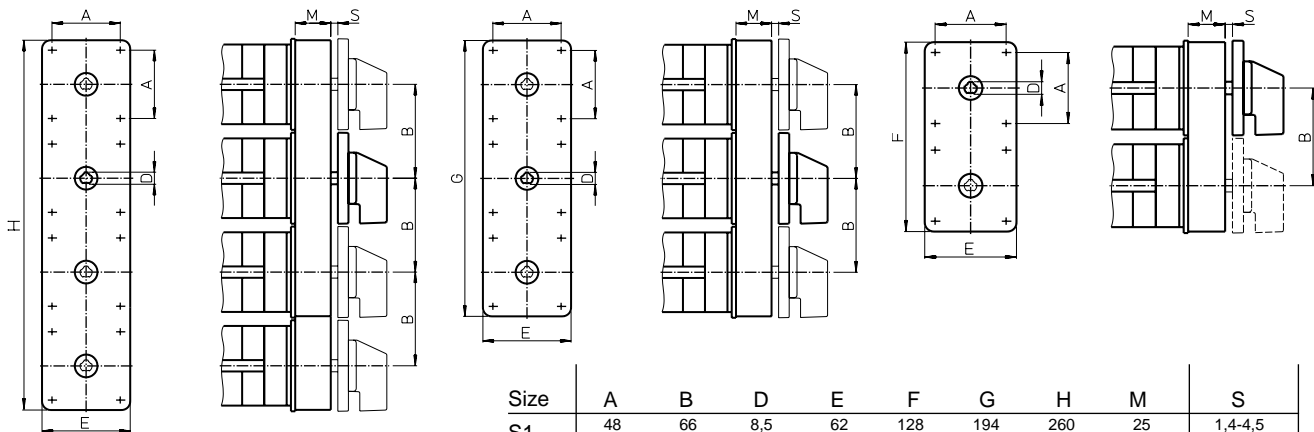

Size	A	B	D	E	F	G	H	M	S
S1	48 1.89	66 2.60	8,5 .34	62 2.44	128 5.04	194 7.64	260 10.24	25 .98	1,4-4,5 .06-.18
S2	68 2.68	93 3.66	11,2 .44	92 3.62	183 7.20	276 10.87	369 14.53	30 1.18	1,5-7,0 .06-.28
S3	88 3.46	144 5.67	14 .55	130 5.13	274 10.79	418 16.47	562 22.13	24 .94	1,5-8,3 .06-.33

Push Button Interlock

V400/A1, V400/A2, V400/B1, V400/B2

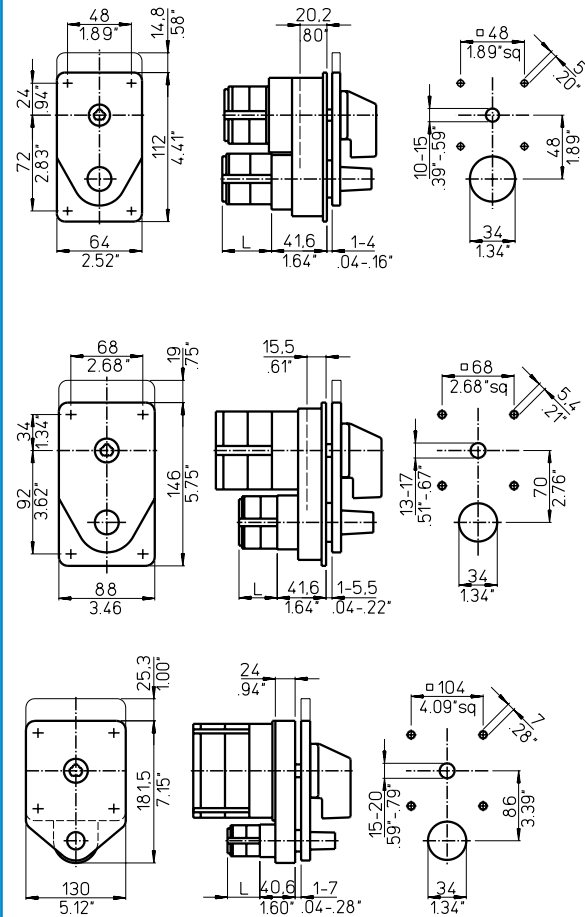

For switches of size S0 and S1

L	No. of auxiliary contacts	
	2	4
	21,7	34,4
	.85	1.35

For switches of size S2

For switches of size S3

< back to table of contents >

Electromechanical Interlock

V140

For switches of size S1

	M
S1	14
CA40-63, A25	36,2

For switches of size S1, S2 and S3

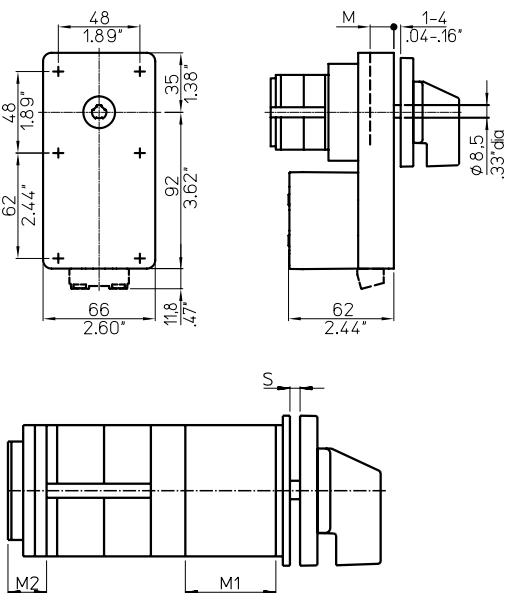

M1 = Additional length for the interlock
M2 = Additional length for the coupling pieces of the solenoid
Additional length for the solenoid upon request.

Size	M1 + M2	S
S1	56	0-4
	2.20	0-.16
S2	102	0-5,5
	4.02	0-.22
S3	111,1	0-7
	4.37	0-.28

Bayonet/Switch Coupling

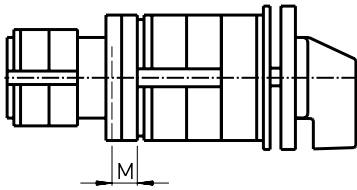

M270

Size	Coupled switch		
	S1	S2	S3
Main switch	M	M	M
S1	9,8 .39		
S2		12,9 .51	
S3			32,9 1.30

M275

Size	Coupled switch			
	S00	S0	S1	S2
Main switch	M	M	M	M
S0	0 0	5,5 .22		
S1	1,3 .05	0,8 .03		
S2	10,2 .40	4,4 .17	2,9 .11	
S3	12,7 .50	12,2 .48	11,4 .45	11,4 .45

Slip Clutch and Ratchet Coupling

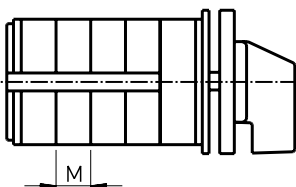

M200, M230

M = One switch stage

Electromechanical Trip Device (Undervoltage Release and Shunt-trip)

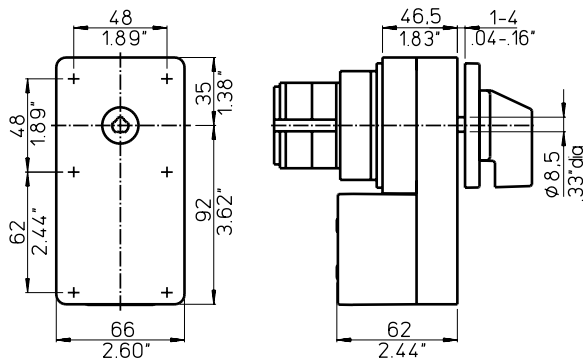

**V350/A, V350/B, V350/D
V360/A, V360/B, V360/D**

Special Drive Units

G800/A

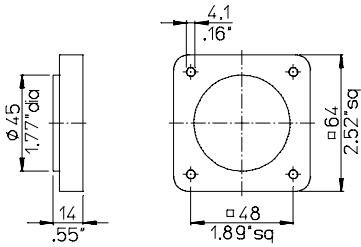

G800/B

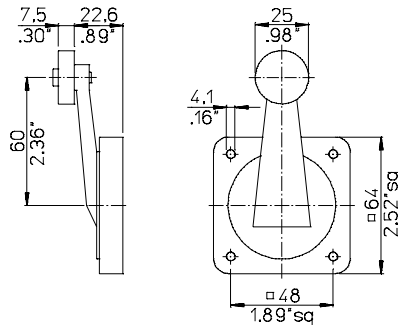

G800/C

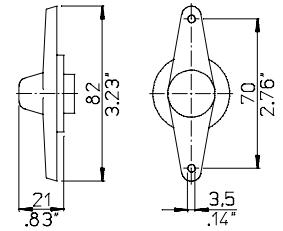

G900/B

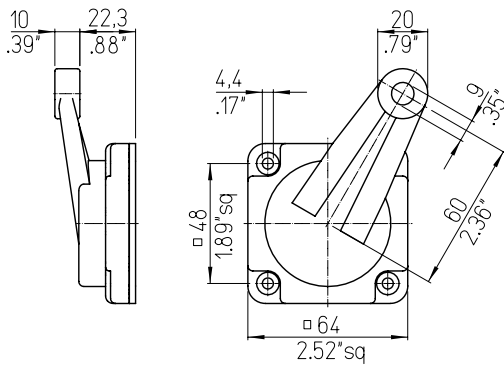

< back to table of contents >

Ground and Neutral Terminal

H040/E, H040/N, H040/NE

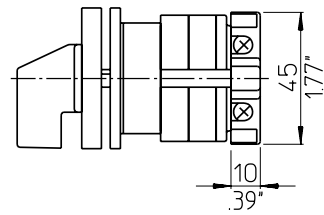

Motor Drive

R300

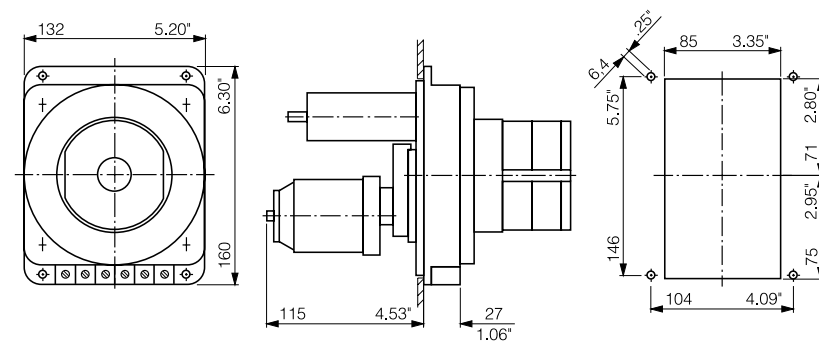

Key-lock Device with small Cylinder Lock

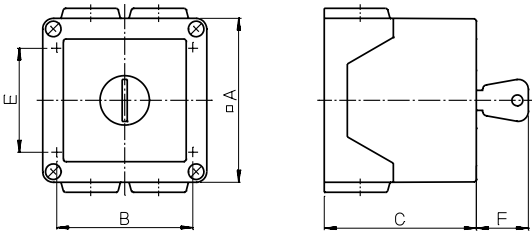

V750

Switch type	No. of stages	A	B	C	E	F	Conduit entries 4 x ISO
CA10	2	64 2.52	50 1.97	68,8 2.71	36 1.42	26 1.02	20
CA11, CA20	1 + 2	82 3.23	68 2.68	75,5 2.97	52 2.05	29 1.14	20

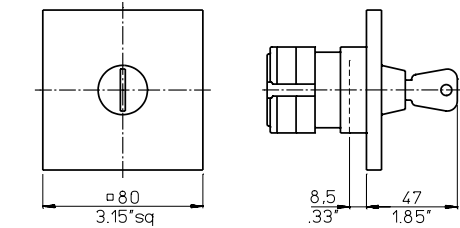

For 1 stage CA10 switches with plaster depth trim

For base mounting with type of mounting VE21

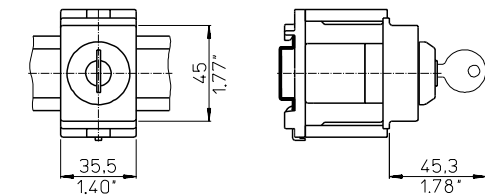

Switch Type	A	L
CA4, CG4	35,57 1.40	45,3 ¹⁾ 1.78
CA10, CA11, CA20, CA25, CG8, CH10, DH10	52,3 2.06	56,6 1.73

Fl.	CA4		CG4		CA10		CA11		CA20		CA25		CG8		CH10		DH10	
	S	S	Smin	Smax	Smin	Smax	Smin	Smax	Smin	Smax	Smin	Smax	Smin	Smax	Smin	Smax	Smin	Smax
1	-	44 1.73	44 1.73	52 2.05	48 1.89	56 2.20	48 1.89	56 2.20	50 1.97	58 2.28	52 2.05	60 2.36	54 2.13	60 2.36	54 2.13	60 2.36	54 2.13	60 2.36
2	44 1.73	54 2.13	54 2.13	60 2.36	60 2.36	68 2.68	60 2.36	68 2.68	64 2.52	72 2.83	64 2.52	72 2.83	68 2.68	74 2.91	68 2.68	74 2.91	72 2.83	74 2.91
3	50 1.97	68 2.68	64 2.52	72 2.83	72 2.83	74 2.91	74 2.91	74 2.91	-	-	-	-	-	-	-	-	-	-
4	58 2.28	-	72 2.83	74 2.91	-	-	-	-	-	-	-	-	-	-	-	-	-	-
5	68 2.68	-	-	-	-	-	-	-	-	-	-	-	-	-	-	-	-	-

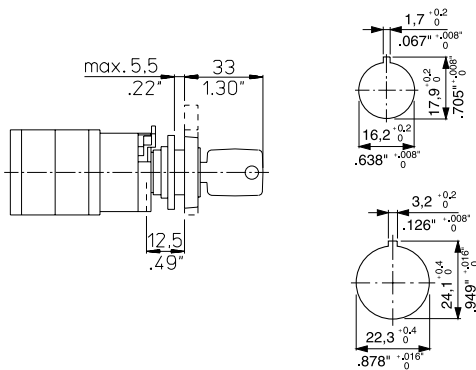

V750D/1 and V750D/2

For single hole mounting combined with 16/22 mm

Front ring 29,5 mm Ø (mounting FS1)

Face plates
30 x 30 mm (mounting FS2)
30 x 39 mm (mounting FS4)

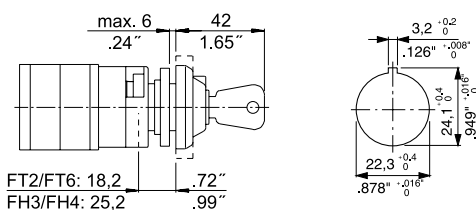

V750D/3

For single hole mounting 22 mm

Front ring 39 mm Ø (mounting FT1)

Face plate
48 x 48 mm (mounting FT2)
64 x 64 mm (mounting FH3)
48 x 59 mm (mounting FT6)
64 x 78,5 mm (mounting FH4)

FT2/FT6: 18,2
FH3/FH4: 25,2

Key-lock Device with Kaba Lock

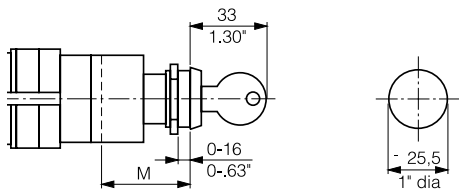

V750D

With front ring (mounting EL)

Locking program	M
1A-1G	37,2 1.46
2G-2L	47,2 1.86

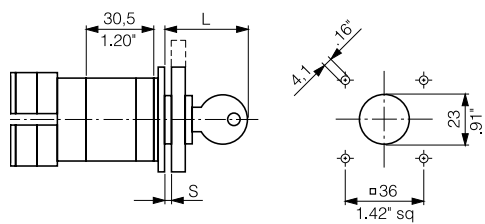

V750D/A, V750D/B

Face plates

48 x 48 mm (mounting E)

48 x 60 mm (mounting E)

Locking program	S	L
1A-1G	1-3,5 .04-.14	40,3 1.59
2G-2L	1-12,5 .04-.49	49,3 1.94

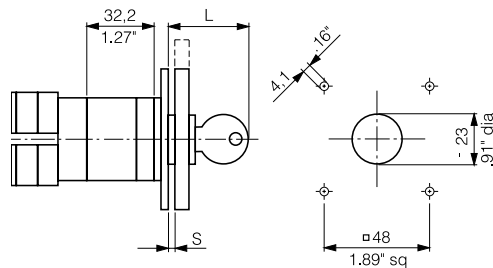

V750D/A, V750D/B

Face plates

64 x 64 mm (mounting EG)

64 x 78,8 mm (mounting EG)

Locking program	S	L
1A-1G	1-3,5 .04-.14	39,8 1.57
2G-2L	1-12,5 .04-.49	48,8 1.92

< back to table of contents >

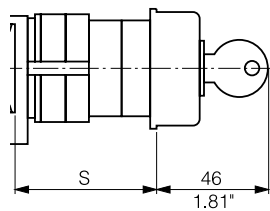

V750D (mounting VE2)

Max. no. of stages	CA10	CA11	CA20	CG8	CH10
S = 50 mm 1.97"	1	-	-	-	-
61 mm 2.40"	2	1	1	1	1
67 mm 2.64"	-	2	2	-	-
69 mm 2.72"	3	2	2	-	-

Key-lock Device with Profile Cylinder

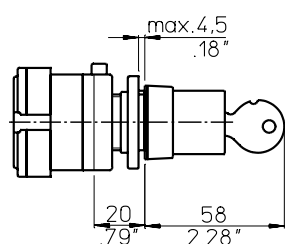

V750E

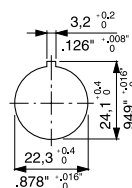

Key-lock Device with Kaba Lock

36
1.42"
45
1.77"
34
1.34"
1-4.5
.04-.18"
3°
12°
19
.75"
40
1.57"

V750/A1

With face plate 64 x 64 mm (mounting EL2)
With front ring (mounting EL1)

Key-lock Device with Half-cylinder Lock

V755.UE1

84
3.31"sq
11
.43"
57
2.24"

V755.E

48
1.89"
4
.16"
48
1.89"
37
1.46"
31.5
1.24"
1-4
.04-.16"

Different drilling plans

4.2
1.77"
20
78
11
.42"
36
1.42"sq
R9
35°
R5.5
217°
4.2
1.77"
36
1.42"sq
8.5
33°
35
1.38"

Safety Key-lock Device with separate Drive

A
G
L
C
M
S
H
D3
B
D1
D2
F

V760/A.E, V760/B.E, V760/A, V760/B

Size of the optional extra	A	B	C	E	F	G
S0	48 1.89	36 1.42	82 3.23	12 .47	40 1.57	24 .94
S1	64 2.52	48 1.89	112 4.41	14.8 .58	48 1.89	32 1.26
S2	88 3.46	68 2.68	146 5.75	-	70 2.76	44 1.73
S3	130 5.12	104 4.09	181.5 7.15	-	86 3.39	65 2.56
	H	D1	D2	D3	M	S
S0	31 1.22	8.5 .33	20 .79	5 .20	9.5 .37	1-4 .04-.16
S1	34.5 1.36	10 .39	34 1.34	5 .20	20.2 .80	1-4 .04-.16
S2	35.5 1.40	12 .47	34 1.34	5.4 .21	15.5 .61	1-5.5 .04-.22
S3	36.5 1.44	15 .59	34 1.34	7 .28	24 .94	1-7 .04-.28

V765

48
1.89"
24
9.4"
96
3.78"
115
4.5"
1-4
.04-.16"
39
1.54"

Different drilling plans

15
78°
40
1.57"
20
78°
11
.42"
36
1.42"sq
R10
35°
R5.5
217°
48
1.89"
35
1.38"

V790

17.3
68°
27
106°
32
1.26"
28
1.10"
64
2.52"

Padlock Device

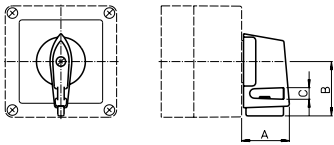

V840A

For 2 padlocks

Size	A	B	C
S0	27,7 1.07	31,5 1.24	5 .20
S1	35 1.38	40 1.57	7 .28

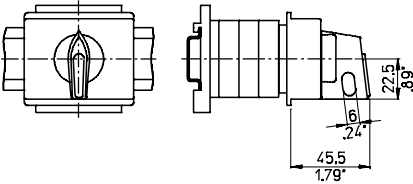

V840B

For 2 padlocks

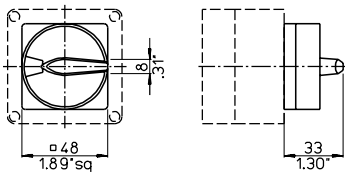

V840D

For 2 padlocks

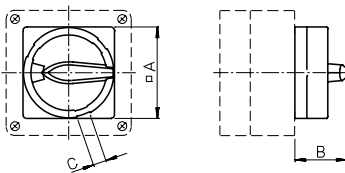

V840G, V840D

For 3 padlocks

	A	B	C
V840G	64 2.52	40,1 1.58	9,2 .36
V840D	88 3.46	49,3 1.94	10 .39

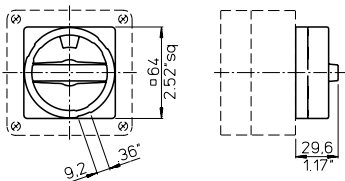

V840G/B

For 3 padlocks

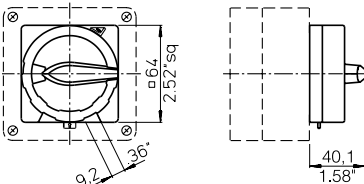

V840F/F

For 4 padlocks

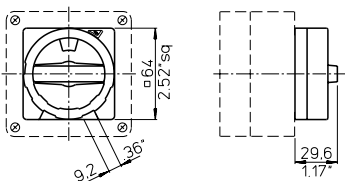

V840F/B

For 4 padlocks

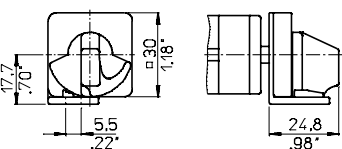

V840K

For 1 padlock

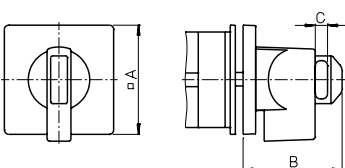

V845, V846 (S1 only)

Size	A	B	C
S0	48 1.89	51 2.01	7,2 .28
S1	64 2.52	58 2.28	8,1 .32
S2	88 3.46	73 2.87	9 .35
S3	130 5.12	86,5 3.41	9,2 .36

< back to table of contents >

Padlock Device

	V841												
	V842												
	V850	For 2 padlocks											
			<table border="1"> <thead> <tr> <th></th> <th>D</th> </tr> </thead> <tbody> <tr> <td>S1 V850/A1</td> <td>10-15/.39-.59</td> </tr> <tr> <td>S1 V850/11</td> <td>8-15/.31-.59</td> </tr> <tr> <td>S1 V850/12</td> <td>10-15/.39-.59</td> </tr> <tr> <td>S1 V850/13</td> <td>19-22/.75-.87</td> </tr> </tbody> </table>		D	S1 V850/A1	10-15/.39-.59	S1 V850/11	8-15/.31-.59	S1 V850/12	10-15/.39-.59	S1 V850/13	19-22/.75-.87
		D											
	S1 V850/A1	10-15/.39-.59											
S1 V850/11	8-15/.31-.59												
S1 V850/12	10-15/.39-.59												
S1 V850/13	19-22/.75-.87												
	For 3 padlocks												
		<table border="1"> <thead> <tr> <th></th> <th>D</th> </tr> </thead> <tbody> <tr> <td>S2 V850/A1</td> <td>26-30/1.02-1.18</td> </tr> <tr> <td>S2 V850/11</td> <td>10-15/.39-.59</td> </tr> <tr> <td>S2 V850/12</td> <td>26-30/1.02-1.18</td> </tr> <tr> <td>S2 V850/13</td> <td>26-30/1.02-1.18</td> </tr> </tbody> </table>		D	S2 V850/A1	26-30/1.02-1.18	S2 V850/11	10-15/.39-.59	S2 V850/12	26-30/1.02-1.18	S2 V850/13	26-30/1.02-1.18	
	D												
S2 V850/A1	26-30/1.02-1.18												
S2 V850/11	10-15/.39-.59												
S2 V850/12	26-30/1.02-1.18												
S2 V850/13	26-30/1.02-1.18												
	For 6 padlocks												
		<table border="1"> <thead> <tr> <th></th> <th>D</th> </tr> </thead> <tbody> <tr> <td>S3 V850/A1</td> <td>15.5-20/.61-.79</td> </tr> <tr> <td>S3 V850/11</td> <td>26-30/1.02-1.18</td> </tr> <tr> <td>S3 V850/12</td> <td>15.5-20/.61-.79</td> </tr> <tr> <td>S3 V850/13</td> <td>22-25/.87-.98</td> </tr> </tbody> </table>		D	S3 V850/A1	15.5-20/.61-.79	S3 V850/11	26-30/1.02-1.18	S3 V850/12	15.5-20/.61-.79	S3 V850/13	22-25/.87-.98	
	D												
S3 V850/A1	15.5-20/.61-.79												
S3 V850/11	26-30/1.02-1.18												
S3 V850/12	15.5-20/.61-.79												
S3 V850/13	22-25/.87-.98												

[< back to table of contents >](#)

PFR (Power Failure Release)

	Size S0						
	Without trip-free release	<table border="1"> <thead> <tr> <th>M</th> </tr> </thead> <tbody> <tr> <td>23,3 .92</td> </tr> <tr> <td>31,5 1.24</td> </tr> </tbody> </table>	M	23,3 .92	31,5 1.24		
M							
23,3 .92							
31,5 1.24							
	With trip-free release						
	Size S1						
		<table border="1"> <thead> <tr> <th colspan="2">M</th> </tr> </thead> <tbody> <tr> <td>S1</td> <td>10,2</td> </tr> <tr> <td>CA40-63, A25</td> <td>22,9</td> </tr> </tbody> </table>	M		S1	10,2	CA40-63, A25
M							
S1	10,2						
CA40-63, A25	22,9						

Lockout-relays

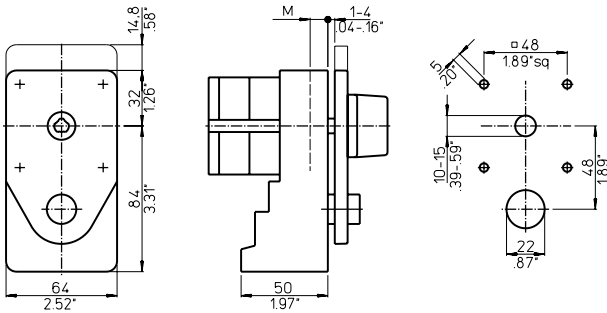

With manual release

	M
S0, S1	10,2
CA40-63, A25	22,9

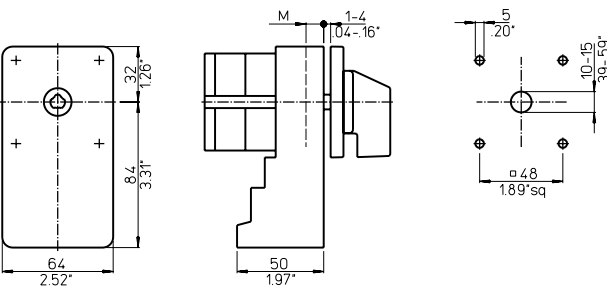

Without manual release

< back to table of contents >

Rectangular Add-on Face Plates

PRA

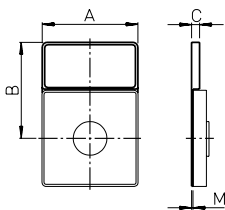

PRB

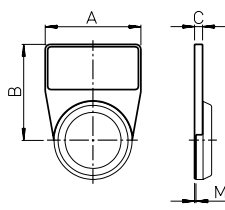

F991/...-..., F991/.../C-...

	PRA					PRB	
	S00	S0	S1	S2	S3	S00	S0
A	29,5 1.16	47,8 1.88	63,8 2.51	87,8 3.46	129,8 5.11	29,5 1.16	47,8 1.88
B	35 1.38	48 1.89	60 2.36	80 3.15	115 4.53	35 1.38	48 1.89
C	4 .16	4 .16	5 .20	6 .24	7 .28	4 .16	4 .16
M	0,7 .03	0,7 .03	0,8 .03	1 .04	1,2 .05	0,7 .03	0,7 .03

PRC

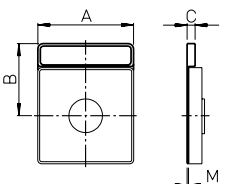

PRD

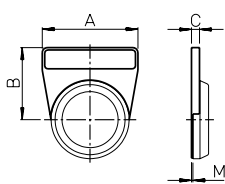

	PRC			PRD	
	S00	S0	S1	S00	S0
A	29,5 1.16	47,8 1.88	63,8 2.51	29,5 1.16	47,8 1.88
B	25,5 .98	36 1.42	47 1.85	25,5 .98	36 1.42
C	4 .16	4 .16	5 .20	4 .16	4 .16
M	0,7 .03	0,7 .03	0,8 .03	0,7 .03	0,7 .03

Plastic Enclosures

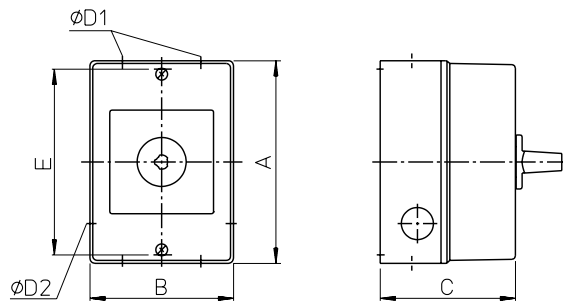

Mounting	Switch type	Max. no. of stages	A	B	C	Conduit entries		
						4 x D1	2 x D2	E
KS3 CS3	CA4	2	90	70	60	16	-	82
	CG4	1	3.54	2.76	2.36	.63		3.23
	CA4	3	90	70	77	16	-	82
	CG4 CG6	2 2	3.54 3.54	2.76 2.76	3.03	.63 .63		3.23 3.23
KS10, KS11, KS12 CS10, CS11, CS12 KS50, KS51, KS52 CS50, CS51, CS52	CA10	4						
	CA11	3						
	CA20, CA25, CG8	2	121	86	80	20/25	20	110
	CH10-CHR16	2	4.76	3.39	3.15	.79/.98	.79	4.33
KS50, KS51, KS52 CS50, CS51, CS52	CA10	6						
	CA11, CA20	5	121	86	106	20/25	20	110
	CA25, CG8, CH10-CHR16	4	4.76	3.39	4.17	.79/.98	.79	4.33
KL10, KL11, KL12 KL50, KL51, KL52 CL50, CL51, CL52 CL10, CL11, CL12	CA10	3						
	CA11, CA20, CA25, CG8	2	160	85	80	20/25	20	150
	CH10-CHR16	2	6.30	3.35	3.15	.79/.98	.79	5.91

[< back to table of contents >](#)

Plastic Enclosures (Front Drive)

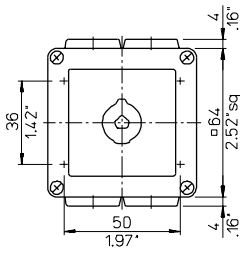

For switch type
CA10

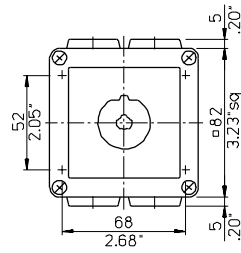

For switch type
CA11, CA20, CA10B,
CA11B, CA20B, CH10,
CH16, CA25

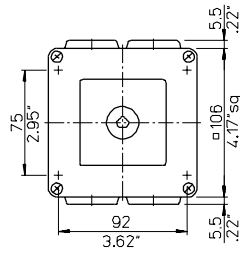

For switch type
A11, A14, CA40, CA50,
CA63

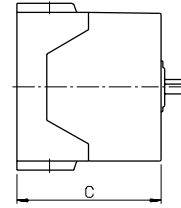

< back to table of contents >

Switch type	No. of stages	PN. C	PF. C	ISO
A11, A25	1 + 3	89	94,5	M25
	4-6	132	137,5	
CA10	1	36,6	41,3	M20
	2	45,8	50,8	
	3	55,3	60,3	
	4	64,8	69,8	
CA11, CA20, CA11B, CA20B	1 + 2	59,7	64,7	M20
CA11, CA20, CA10B, CA11B, CA20B	3 + 4 ¹	85,1	90,1	M20
CH10, CH16	1	59,7	64,7	M20
	2 + 3	85,1	90,1	
	4	93	98	
CA25	1 + 2	59,7	64,7	M20
	3	85,1	90,1	
	4	93	98	
CA40, CA50, CA63	1	67,5	73	M25
	2 + 3	89	94,5	
	4 - 6	132	137,5	

¹CA10B only for 4 stages

Plastic Enclosures (Lateral Drive)

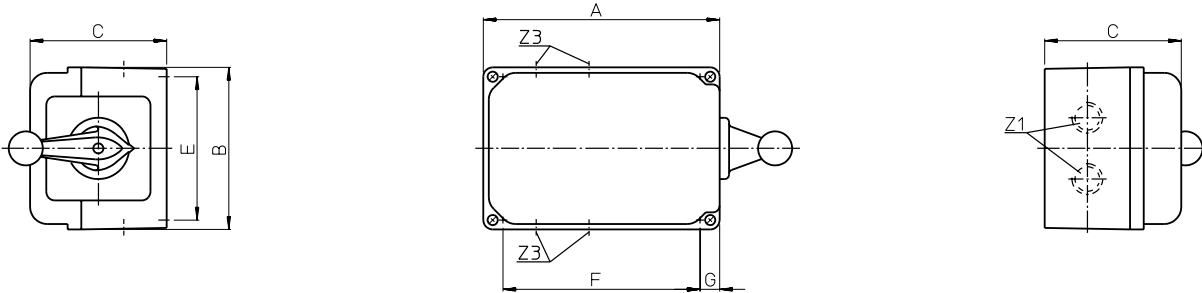

Switch type	Max. no. of stages	A	B	C	E	F	G	Conduit entries		
								Z1	Z3	ISO
CA10, CA10R, CAD11, CAD12, CA10B A11, CA11, CA20, CA11B, CA20B	4 3	92 3.62	90 3.54	75 2.95	80 3.15	68 2.68	12 .47	●	-	M25
CA10, CA10R, CAD11, CAD12 CA10B A11, CA11, CA20, CA11B, CA20B	7 6 5	115 4.53	90 3.54	75 2.95	80 3.15	91 3.58	12 .47	-	●	M25
CA10, CA10R, CAD11, CAD12 CA10B A11, CA11, CA20, CA11B, CA20B	10 9 7	140 5.51	90 3.54	75 2.95	80 3.15	116 4.57	12 .47	-	●	M25
CA10, CA10R, CAD11, CAD12, CA10B A11, CA11, CA20, CA11B, CA20B	12 9	165 6.50	90 3.54	75 2.95	80 3.15	141 5.55	12 .47	-	●	M25
A11, CA11, CA20, CA11B, CA20B	11	190 7.48	90 3.54	75 2.95	80 3.15	166 6.54	12 .47	-	●	M25
A11, CA11, CA20, CA11B, CA20B	12	215 8.46	90 3.54	75 2.95	80 3.15	191 7.52	12 .47	-	●	M25

Aluminum Enclosures

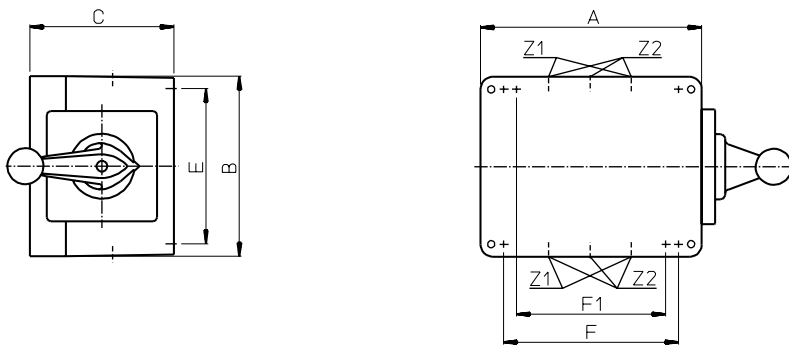

Switch types	No. of stages	A	B	C	E	F	F1	Conduit entries		
								Z1	Z2	ISO
CA10, CA10R CA11, CA20	3 2	80 3.15	75 2.95	57 2.24	63 2.48	-	52 2.05	●	-	M20
CA10B CA11B, CA20B CA25B	4 3 2	100 3.94	100 3.94	80 3.15	86 3.39	66 2.60	-	●	-	M20
A11, A14 CA10B CA11B CA20B, CA25B CA40, CA50, CA63	5 7 6 5 5	140 5.51	140 5.51	90 3.54	120 4.72	93 3.66	-	●	-	M25
A11, A14 CA10B CA11B, CA20B CA25B CA40, CA50, CA63	10 12 10 9 10	200 7.87	140 5.51	90 3.54	93 3.66	180 7.09	-	-	●	M25

Notes:

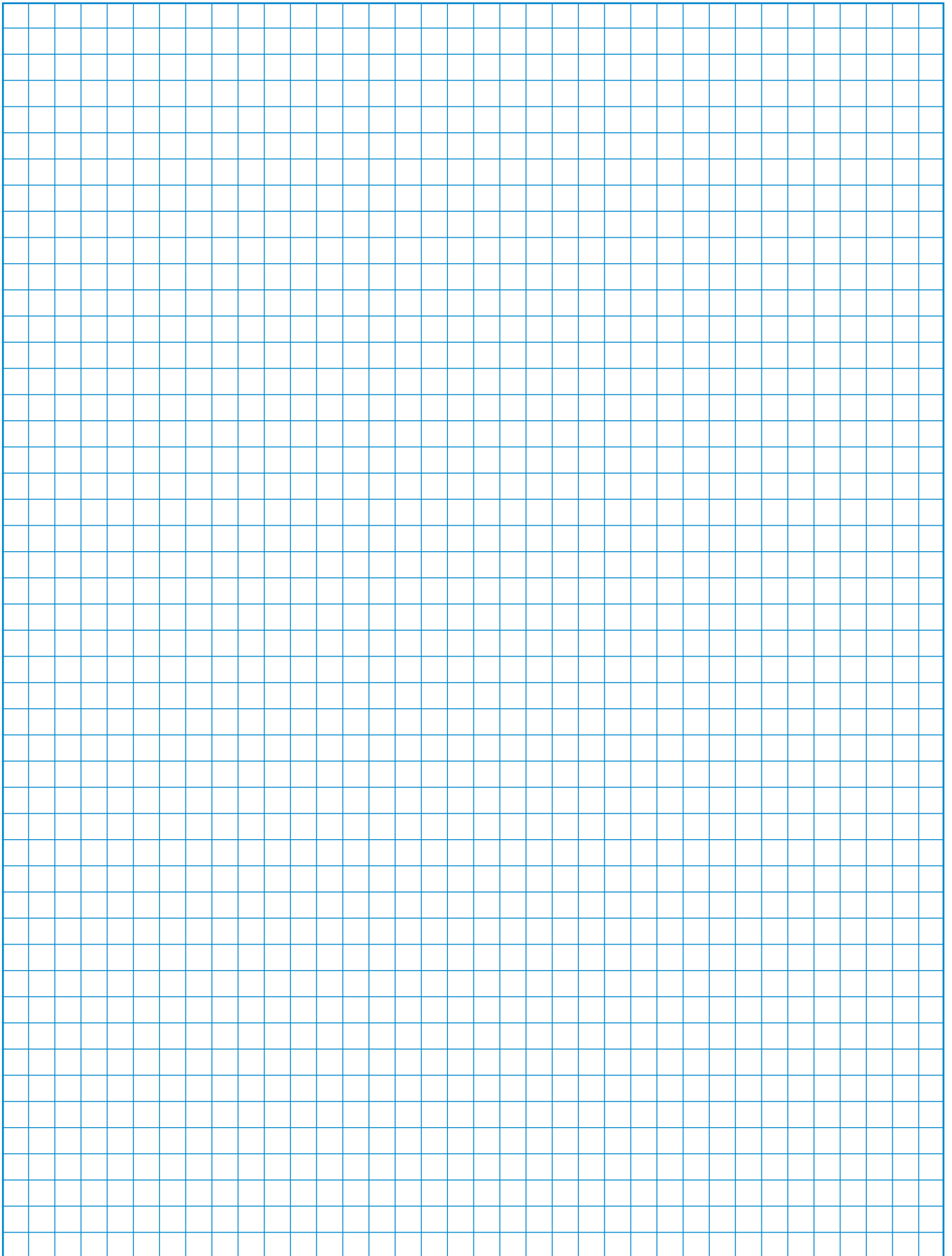

The Range of “Blue Line” Switchgear

Technical literature covering the following products is available on request.

	Catalog Number
Main Switches and Main Switches with Emergency Function 16 A-315 A Maintenance Switches 20 A-315 A Switch Disconnectors 20 A-315 A According to IEC 60947-3, EN 60947-3, VDE 0660 part 107, IEC 60204, EN 60204 and VDE 0113	500
C, CA and CAD Switches 10 A-315 A and L Switches 350 A-2400 A C, CA and CAD switches are designed for universal application. They are recommended for instrument, isolator, double-throw and motor control. L switches are designed for load and off-load applications. They are used to switch resistive or low inductive loads.	100
Optional Extras and Enclosures The complete product line, a large number of optional extras is available, including door interlocks, push-pull devices, cylinder and padlock attachments, control and indicator devices, AC motor drives, as well as enclosures, both insulated and metal.	101
A and AD Switches 6 A-25 A A and AD switches have 4 contacts in each switching stage. These switches provide an extensive range of switch functions and require a minimum mounting depth. Up to 24 switching positions are possible, with availability of 48 contacts per 12 stage switch column.	110
CG, CH and CHR Switches 10 A-25 A Ultra compact CG, CH and CHR switches are ideally suited for control and instrumentation applications. Switch terminals are “finger-proof” and conveniently accessible for wiring and are delivered open. All CG4 switches offer specially designed gold plated contacts or H-bridges with “cross-wire” contact systems, which facilitates their use in electronic circuitry and chemically aggressive environments.	120
DH, DHR, DK and DKR Switches 6 A-16 A DH, DHR, DK and DKR switches incorporate unique corrosion resistant contacts that permit operation on system voltage as low as 1 V. They have fully enclosed and protected contacts which can be operated either by rotary and/or lateral handle movement. D switches are used in calibration and semiconductor circuits. They are also used for relay and contactor control.	130
X Switches 200 A-630 A X switches can be applied for load, tap and gang switching duties. They incorporate 6 contacts in each switching stage. Their compact design provides a minimum length dimension for mounting purposes.	140
KG Switches 20 A-315 A and KH and KHR Switches 16 A-80 A KG, KH and KHR switches are excellent circuit interruptors. They have high through fault and fault making capacities and are especially designed for use as isolators and safety switches for machine tools, distribution panels and switchboards. KG ON/OFF switches offer unusually high dimensioned air and creepage distances between terminals which are designed for time saving “straight-line” wiring. ON/OFF switches are available with up to 8 poles and double-throw switches are available with up to 4 poles.	150
Push Buttons and Pilot Lights, 22,5 mm Ø A complete range of state-of-the-art push buttons and pilot lights represent an ideal combination of functional security and economical efficiency in a modular design.	302

SALES AND SERVICE ORGANIZATION

Australia

Kraus & Naimer Pty. Ltd.
379 Liverpool Road, ASHFIELD, N.S.W. 2131
Tel: +61 2 9797-7333, Fax: 0092
salesaus@krausnaimer.com

Austria

Kraus & Naimer GmbH
Schumanngasse 35
1180 WIEN
Tel: +43 1 404 06-0, Fax: 404 06-190
aso@krausnaimer.com

Belgium, Luxembourg

Kraus & Naimer B.V.
Ikaros Business Park
Ikaroslaan 2
1930 ZAVENTHEM
Tel: +32 2 757-0141, Fax: 1640
sales.be@krausnaimer.com

Brazil

Central and South America
Kraus & Naimer Ind. Com. Ltda.
Rua Santa Monica, 1061
Parque Industrial San Jose
06715-865 Cotia - SP
Tel: +55 11 2198-1288, Fax: 1251
knbrasil@krausnaimer.com.br

Canada

Kraus & Naimer Ltd.
219 Connie Crescent, Unit: 13A
CONCORD, Ontario, L4K 1L4
Tel: +1 905 738-1666, Fax: 9327
salescan@krausnaimer.com

Cyprus

ELECTROMATIC CONSTRUCTIONS LTD.
72, Evagoras Pellikarides Str., 2235 LATSIA-Nicosia
P. O. Box 12630, 2251 LATSIA-Nicosia
Tel: +357 2 48 41 41, Fax: 48 57 47

Czech Republic

OBZOR, výrobní družstvo Zlín
Na Slanici 378
76413 ZLÍN
Tel: +420 57 7195-111/-153 (Techn. Supp.)
Fax: +420 57 7195-152/-138
ots@obzor.cz

Denmark

THIIM A/S
Transformervej 31
2730 HERLEV
Tel: +45 4485 8000, Fax: 8005
thiim@thiim.com

Finland

Kraus & Naimer Oy
Kiitoradankuja 8
01530 VANTAA
Tel: +358 9 825-424-0, Fax: 424-10
myynti@krausnaimer.com

France

Kraus & Naimer s.a.s.
33, rue Bobillot
75013 PARIS
Tel: +33 1 58 40 80 80, Fax: 45 80 91 19
ventes@krausnaimer.com

Germany

Kraus & Naimer GmbH
Wikingerstraße 20-28, 76189 KARLSRUHE
Postfach 10 01 24, 76231 KARLSRUHE
Tel: +49 721 59 88-0, Fax: 59 28 28
sales.ger@krausnaimer.com

Great Britain

Kraus & Naimer Ltd.
115 London Road
NEWBURY/BERKSHIRE RG14 2AH
Tel: +44 1635 262626, Fax: 37807
sales-uk@krausnaimer.com

Greece

KALAMARAKIS-SAPOUNAS S. A.
Ionias & Neromilou Str., P. O. Box 46566
13671 ACHARNES/ATHENS
Tel: +30 2 10 240-6000-6, Fax: 240-6007
kalamarakis.sapounas@ksa.gr

Hungary

GANZ, Schalter- u. Gerätefabrik
X. Kőbányal út 41/c, Postfach 87
1475 BUDAPEST
Tel: +36 1 261-5479, Fax: 4685
ganzkk@ganzkk.hu

Iceland

JOHAN RÖNNING LTD.
Klettagarðar 25
104 REYKJAVÍK
Tel: +354 5200 800
ronning@ronning.is

India

BLISS ELECTRICALS Pvt. Ltd.
SA42 A&B, 2nd Flr, Lake City Mall,
Kapurbavdi Junction,
THANE (W) - 400 607
Tel: +91-22-25368609
kane.shriram@blisselectricals.com

Republic of Ireland

Kraus & Naimer Ltd.
4235 Atlantic Avenue
Westpark Business Campus
Shannon, Co. Clare
Tel: +353 61 704700, Fax: 471084
sales-ie@krausnaimer.com

Italy

Kraus & Naimer s.r.l.
Via Terracini, 9
24047 TREVIGLIO (BG)
Tel: +39 0363-30 11 12, Fax: 30 21 13
SalesItaly@krausnaimer.com

Japan

Kraus & Naimer Ltd.
Yoshiwada Building 2F
1-11-6 Hamamatsucho
Minato-Ku, TOKYO 105-0013
Tel: +81 3 3436-6151, Fax: 6325
sales-jpn@krausnaimer.com

Mexico

JC Ingeniería y Control, SA de CV.
Ángel Gaviño 30.
C. Satélite, C. Medicos,
Naucalpan Edo. de Mexico, C.P. 53100
Tel. (+52 55) 55 62 75 77, Fax. 55 62 04 34
ventas@jcingeneriaycontrol.com

Middle East - UAE

Branch Office, Kraus & Naimer Pte. Ltd.
SAIF Zone, P. O. Box 121607,
Sharjah, UAE
Tel: +971 6 557 8886
Fax: +971 6 557 8088
uae@krausnaimer.com

Netherlands

Kraus & Naimer B.V.
Wegtersweg 38-40, Postbus 199
7556 BR HENGEL0 (Ov.)
Tel: +31 74 291-9441, Fax: 8380
sales.nl@krausnaimer.com

New Zealand

Kraus & Naimer Ltd.
42 Miramar Avenue, WELLINGTON 6022
P. O. Box 15-009, WELLINGTON 6243
Tel: +64 4 380-9888, Fax: 9877
sales-nz@krausnaimer.com

Norway

Kraus & Naimer AS
Hjalmar Brantings vei 8, P. O. Box 21, Økern
0508 OSLO
Tel: +47 22 64 44 20, Fax: 65 39 49
ordre.no@krausnaimer.com

Poland

ASTAT sp. z o.o.
ul. Dąbrowskiego 461
60451 POZNAN
Tel: +48 61 848-8871/72, Fax: 8276
info@astat.com.pl

Portugal

ELECTRICOL-DAMAS, FERREIRA & DAMASCENO, LDA.
Apartado 1063, S. Ant. Cavaleiros
2670 LOURES
Tel: +351 21 989-8939, Fax: 988-6464
electrical@electricol.pt

Singapore

Kraus & Naimer Pte. Ltd.
Blk 115A, Commonwealth Drive
#03-17/23
SINGAPORE 149 596
Tel: +65 6473-8166, Fax: 8643
sgp@krausnaimer.com

Slovenia

SCHRACK Technik d.o.o.
Pameče 175
2380 Slovenj Gradec
Tel: +386 2 883 92 00, Fax: +386 2 884 34 71
m.abeln@schrack.si

Republic of South Africa

Kraus & Naimer Pty. Ltd.
7 Village Crescent, Linbro Village
Linbro Business Park, SANDTON 2065
P. O. Box 511, KELVIN 2054
Tel: +27 11 608-6060, Fax: 608-2874
salesZAF@krausnaimer.com

Spain

Kraus & Naimer B.V.
Tel: +34 662 696 014
sales.es@krausnaimer.com

Sweden

Kraus & Naimer AB
Dr. Widerströms Gata 11, FRUÅNGEN
Box 42097, 126 14 STOCKHOLM
Tel: +46 8 97 00 80, Fax: 97 87 33
order.se@krausnaimer.com

Switzerland

AWAG Elektrotechnik AG
Sandbühlstraße 2, Postfach
8604 VOLKETSCHWIL
Tel: +41 44 908 19 19, Fax: 19 99
info@awag.ch, www.awag.ch

Turkey

KARDEŞ ELEKTRİK SANAYİ VE TİCARET ANONİM ŞİRKETİ
Beşyol, Eski Londra Asfaltı-6
34295 İSTANBUL-Sefaköy
Tel: +90 212 624-9204, Fax: 592-4810
info@unalkardes.com.tr

USA

Kraus & Naimer Inc.
760 New Brunswick Road
SOMERSET, NJ 08873
Tel: +1 732 560-1240, Fax: 8823
salesusa@krausnaimer.com



Kraus & Naimer

BLUE LINE switchgear



Contact us:

www.krausnaimer.com